

NARROW CARRIAGE PRINTER CROSS-REFERENCE

These wide carriage labels will not fit narrow carriage (80-column) printers. Identical labels on narrow carriage liners are listed below.



Print your own wire markers in-house as you need them. (Product shown: DAT-5-502)

WIDE CARRIAGE MODELS NARROW CARRIAGE EQUIVALENTS

Part Number	Specifications On Page	Part Number	Specifications On Page
DAT-1-637	143	DAT-49-637	143
DAT-2-637	144	DAT-72-637	144
DAT-8-292	154	DAT-63-292	154
DAT-9-292	155	DAT-75-292	155
DAT-10-637	144	DAT-73-637	144
DAT-12-502	145	DAT-64-502	145
DAT-14-292	155	DAT-65-292	155
DAT-23-637	144	DAT-74-637	144
DAT-30-292	154	DAT-66-292	154
DAT-31-502	142	DAT-67-502	142
DAT-32-632	142	DAT-68-632	142
DAT-41-292	154	DAT-69-292	154
DAT-42-292	154	DAT-70-292	154
DAT-55-642	154	DAT-71-642	154

L

Labels Index by Size

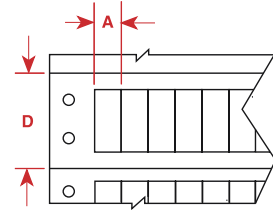
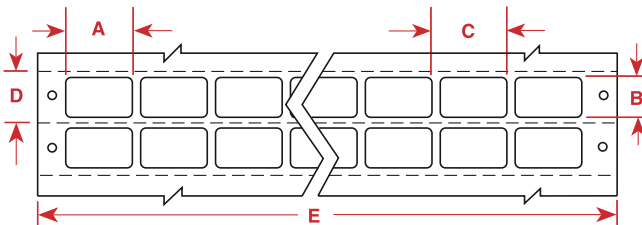

DAT-137-502-10

Dot Matrix Technology Die # 137, .30" x .75" Rating Plate Package Quantity, 10,000 Material B-502, White Vinyl Cloth

PART NUMBER EXPLANATION:

Most Brady part numbers for computer printable labels follow the same four-part format: The first code indicates the technology, the second part is a number indicating the die size used (where applicable), the third part indicates the Brady material used (where applicable), and the final code indicates package quantity.

Part Number	Pieces Per Package	Material	Color	Labels Per Row	Label Width Inch (mm) A	Label Height Inch (mm) B	Horizontal Repeat Inch (mm) C	Vertical Repeat Inch (mm) D	Web Width Inch (mm) E
.30" Label Width — 6 or 8 lines per inch — Square Corners									
DAT-137-502-1,-10	1,000/10,000	Vinyl Cloth	White	16	.30 (7.62)	.75 (19.05)	.30 (7.62)	1.00 (25.40)	5.80 (147.32)
DAT-138-632-1,-10	1,000/10,000	Polyvinylfluoride	White	16	.30 (7.62)	.75 (19.05)	.30 (7.62)	1.00 (25.40)	5.80 (147.32)
DAT-140-502-1,-10	1,000/10,000	Vinyl Cloth	White	16	.30 (7.62)	.937 (23.80)	.30 (7.62)	1.00 (25.40)	5.80 (147.32)
DAT-141-632-1,-10	1,000/10,000	Polyvinylfluoride	White	16	.30 (7.62)	.937 (23.80)	.30 (7.62)	1.00 (25.40)	5.80 (147.32)
.375" Label Width — 6 or 8 lines per inch									
DAT-113-164-1,-10	1,000/10,000	Polyester	Silver	16	.375 (9.53)	.375 (9.53)	.50 (12.70)	.50 (12.70)	8.90 (226.06)
DAT-114-673-1,-10	1,000/10,000	Polyester	White	16	.375 (9.53)	.375 (9.53)	.50 (12.70)	.50 (12.70)	8.90 (226.06)
DAT-115-652-1,-10	1,000/10,000	Polyimide	Amber	16	.375 (9.53)	.375 (9.53)	.50 (12.70)	.50 (12.70)	8.90 (226.06)
DAT-116-658-1,-10	1,000/10,000	Polyimide	Amber	16	.375 (9.53)	.375 (9.53)	.50 (12.70)	.50 (12.70)	8.90 (226.06)
DAT-117-607-1,-10	1,000/10,000	Tamper-Resistant Vinyl	White	16	.375 (9.53)	.375 (9.53)	.50 (12.70)	.50 (12.70)	8.90 (226.06)
DAT-118-619-1,-10	1,000/10,000	Polyester	White	16	.375 (9.53)	.375 (9.53)	.50 (12.70)	.50 (12.70)	8.90 (226.06)
DAT-119-502-1,-10	1,000/10,000	Vinyl Cloth	White	16	.375 (9.53)	.375 (9.53)	.50 (12.70)	.50 (12.70)	8.90 (226.06)

Note: Labels in chart are sorted in order by width, height, 3 digit material number (within part number), then die number (within part number).

LASER, INK JET & DOT MATRIX LABELS

DOT MATRIX LABELS INDEX BY SIZE

Labels Index by Size

CONTINUED

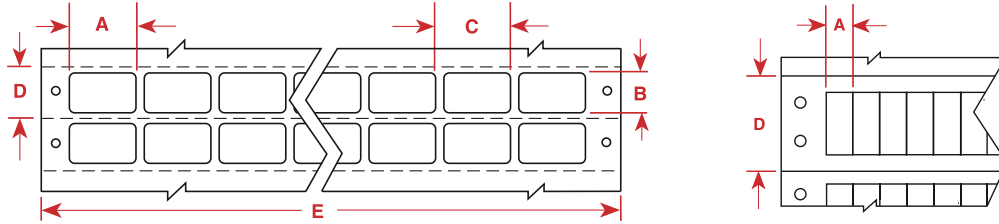

Part Number	Pieces Per Package	Material	Color	Labels Per Row	Label Width Inch (mm) A	Label Height Inch (mm) B	Horizontal Repeat Inch (mm) C	Vertical Repeat Inch (mm) D	Web Width Inch (mm) E
.40" Label Width — 6 or 8 lines per inch									
DAT-179-619-1,-10	1,000/10,000	Polyester	White	16	.40 (10.16)	.20 (5.08)	.50 (12.70)	.250 (6.35)	8.90 (226.06)
DAT-179-652-1	1,000	Polyimide	Amber	16	.40 (10.16)	.20 (5.08)	.50 (12.70)	.250 (6.35)	8.90 (226.06)
DAT-178-619-1	1,000	Polyester	White	16	.40 (10.16)	.50 (12.70)	.50 (12.70)	.667 (16.94)	8.90 (226.06)
.437" Label Width — 6 or 8 lines per inch									
DAT-61-502-1,-10	1,000/10,000	Vinyl Cloth	White	12	.437 (11.10)	2.562 (65.07)	.60 (15.24)	3.00 (76.20)	8.00 (203.20)
DAT-62-502-1,-10	1,000/10,000	Vinyl Cloth	White	12	.437 (11.10)	3.625 (92.08)	.60 (15.24)	4.00 (101.60)	8.00 (203.20)
.50" Label Width — 6 or 8 lines per inch									
DAT-67-499-1,-10	1,000/10,000	Nylon Cloth	White	12	.50 (12.70)	.75 (19.05)	.60 (15.24)	1.00 (25.40)	8.10 (205.74)
DAT-67-502-1,-10	1,000/10,000	Vinyl Cloth	White	12	.50 (12.70)	.75 (19.05)	.60 (15.24)	1.00 (25.40)	8.10 (205.74)
DAT-68-632-1,-10	1,000/10,000	Polyvinylfluoride	White	12	.50 (12.70)	.75 (19.05)	.60 (15.24)	1.00 (25.40)	8.10 (205.74)
DAT-31-502*-1,-10	1,000/10,000	Vinyl Cloth	White	14	.50 (12.70)	.75 (19.05)	.60 (15.24)	1.00 (25.40)	9.30 (236.22)
DAT-32-632*-1,-10	1,000/10,000	Polyvinylfluoride	White	14	.50 (12.70)	.75 (19.05)	.60 (15.24)	1.00 (25.40)	9.30 (236.22)
DAT-21-110-1,-10	1,000/10,000	Saturated Paper	White	12	.50 (12.70)	1.437 (36.5)	.60 (15.24)	1.50 (38.10)	8.10 (205.74)
DAT-24-499-1,-10	1,000/10,000	Nylon Cloth	White	12	.50 (12.70)	1.437 (36.5)	.60 (15.24)	1.50 (38.10)	8.10 (205.74)
DAT-24-502-1,-10	1,000/10,000	Vinyl Cloth	White	12	.50 (12.70)	1.437 (36.5)	.60 (15.24)	1.50 (38.10)	8.10 (205.74)
.50" Label Width — 6 or 8 lines per inch — Square Corners									
DAT-43-502-1,-10	1,000/10,000	Vinyl Cloth	White	16	.50 (12.70)	.437 (11.10)	.50 (12.70)	.50 (12.70)	9.00 (228.60)
DAT-44-607-1,-10	1,000/10,000	Tamper-Resistant Vinyl	White	16	.50 (12.70)	.437 (11.10)	.50 (12.70)	.50 (12.70)	9.00 (228.60)
DAT-45-619-1,-10	1,000/10,000	Polyester	White	16	.50 (12.70)	.437 (11.10)	.50 (12.70)	.50 (12.70)	9.00 (228.60)
DAT-46-693-1,-10	1,000/10,000	Metallized Polyester	Silver	16	.50 (12.70)	.437 (11.10)	.50 (12.70)	.50 (12.70)	9.00 (228.60)
DAT-46-969-1,-10	1,000/10,000	Metallized Polyester	Silver	16	.50 (12.70)	.437 (11.10)	.50 (12.70)	.50 (12.70)	9.00 (228.60)
DAT-98-673-1,-10	1,000/10,000	Polyester	Silver	16	.50 (12.70)	.437 (11.10)	.50 (12.70)	.50 (12.70)	9.00 (228.60)
DAT-143-502-1,-10	1,000/10,000	Vinyl Cloth	White	16	.50 (12.70)	.937 (23.80)	.50 (12.70)	1.00 (25.40)	9.00 (228.60)
DAT-144-632-1,-10	1,000/10,000	Polyvinylfluoride	White	16	.50 (12.70)	.937 (23.80)	.50 (12.70)	1.00 (25.40)	9.00 (228.60)
DAT-171-652-1,-10	1,000/10,000	Polyimide	Amber	16	.50 (12.70)	.437 (11.10)	.50 (12.70)	.50 (12.70)	9.00 (228.60)
.65" Label Width — 6 or 8 lines per inch									
DAT-15-129-1,-10	1,000/10,000	Paper	White	10	.65 (16.51)	.20 (5.08)	.80 (20.32)	.25 (6.35)	8.85 (224.80)
DAT-15-502-1-10	1,000/10,000	Vinyl Cloth	White	10	.65 (16.51)	.20 (5.08)	.80 (20.32)	.25 (6.35)	8.85 (224.80)
DAT-15-502-10-RF	10,000	Vinyl Cloth	White	10	.65 (16.51)	.20 (5.08)	.80 (20.32)	.25 (6.35)	8.85 (224.80)
DAT-16-607-1,-10	1,000/10,000	Tamper-Resistant Vinyl	White	10	.65 (16.51)	.20 (5.08)	.80 (20.32)	.25 (6.35)	8.85 (224.80)
DAT-17-619-1,-10	1,000/10,000	Polyester	White	10	.65 (16.51)	.20 (5.08)	.80 (20.32)	.25 (6.35)	8.85 (224.80)
DAT-56-637-1,-10	1,000/10,000	Tedlar®	White	10	.65 (16.51)	.20 (5.08)	.80 (20.32)	.25 (6.35)	8.85 (224.80)
DAT-58-652-1,-10	1,000/10,000	Polyimide	Amber	10	.65 (16.51)	.20 (5.08)	.80 (20.32)	.25 (6.35)	8.85 (224.80)
DAT-88-693-1,-10	1,000/10,000	Polyester	Silver	10	.65 (16.51)	.20 (5.08)	.80 (20.32)	.25 (6.35)	8.85 (224.80)
DAT-88-969-1,-10	1,000/10,000	Polyester	Silver	10	.65 (16.51)	.20 (5.08)	.80 (20.32)	.25 (6.35)	8.85 (224.80)
DAT-109-658-1,-10	1,000/10,000	Polyimide	Amber	10	.65 (16.51)	.20 (5.08)	.80 (20.32)	.25 (6.35)	8.85 (224.80)
DAT-111-164-1,-10	1,000/10,000	Polyester	Silver	10	.65 (16.51)	.20 (5.08)	.80 (20.32)	.25 (6.35)	8.85 (224.80)

RF=These parts are supplied on a three inch core for those applications requiring a rollform feed mechanism into the printer. The parts are shipped with a 48 hour lead time.

Tedlar® is a registered trademark of DuPont.

* Size does not fit narrow carriage (80-column) printers. See p. 141 for identical narrow carriage labels.

Note: Labels in chart are sorted in order by width, height, 3 digit material number (within part number), then die number (within part number).

Labels Index by Size

CONTINUED

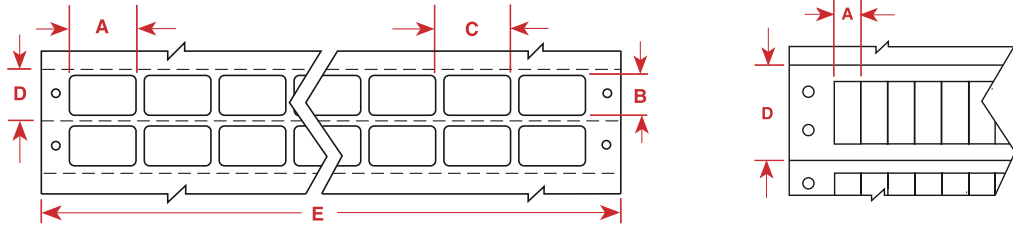

Part Number	Pieces Per Package	Material	Color	Labels Per Row	Label Width Inch (mm) A	Label Height Inch (mm) B	Horizontal Repeat Inch (mm) C	Vertical Repeat Inch (mm) D	Web Width Inch (mm) E
.75" Label Width — 6 lines per inch									
DAT-25-129-1,-10	1,000/10,000	Vinyl Cloth	White	9	.75 (19.05)	.25 (6.35)	.90 (22.86)	.33 (8.46)	9.00 (228.60)
DAT-25-502-1,-10	1,000/10,000	Vinyl Cloth	White	9	.75 (19.05)	.25 (6.35)	.90 (22.86)	.33 (8.46)	9.00 (228.60)
DAT-25-502-10-RF	10,000	Vinyl Cloth	White	9	.75 (19.05)	.25 (6.35)	.90 (22.86)	.33 (8.46)	9.00 (228.60)
DAT-26-607-1,-10	1,000/10,000	Tamper-Resistant Vinyl	White	9	.75 (19.05)	.25 (6.35)	.90 (22.86)	.33 (8.46)	9.00 (228.60)
DAT-27-619-1,-10	1,000/10,000	Polyester	White	9	.75 (19.05)	.25 (6.35)	.90 (22.86)	.33 (8.46)	9.00 (228.60)
DAT-89-969-1,-10	1,000/10,000	Polyester	Silver	9	.75 (19.05)	.25 (6.35)	.90 (22.86)	.33 (8.46)	9.00 (228.60)
DAT-96-652-1,-10	1,000/10,000	Polyimide	Amber	9	.75 (19.05)	.25 (6.35)	.90 (22.86)	.33 (8.46)	9.00 (228.60)
DAT-110-658-1,-10	1,000/10,000	Polyimide	Amber	9	.75 (19.05)	.25 (6.35)	.90 (22.86)	.33 (8.46)	9.00 (228.60)
DAT-112-164-1,-10	1,000/10,000	Polyester	Silver	9	.75 (19.05)	.25 (6.35)	.90 (22.86)	.33 (8.46)	9.00 (228.60)
DAT-161-637-1,-10	1,000/10,000	Polyvinylfluoride	White	9	.75 (19.05)	.25 (6.35)	.90 (22.86)	.33 (8.46)	9.00 (228.60)
.75" Label Width — 8 lines per inch									
DAT-124-502-1,-10	1,000/10,000	Vinyl Cloth	White	9	.75 (19.05)	.25 (6.35)	.90 (22.86)	.375 (9.53)	9.00 (228.60)
DAT-125-607-1,-10	1,000/10,000	Tamper-Resistant Vinyl	White	9	.75 (19.05)	.25 (6.35)	.90 (22.86)	.375 (9.53)	9.00 (228.60)
DAT-126-619-1,-10	1,000/10,000	Polyester	White	9	.75 (19.05)	.25 (6.35)	.90 (22.86)	.375 (9.53)	9.00 (228.60)
DAT-127-969-1,-10	1,000/10,000	Polyester	Silver	9	.75 (19.05)	.25 (6.35)	.90 (22.86)	.375 (9.53)	9.00 (228.60)
DAT-128-652-1,-10	1,000/10,000	Polyimide	Amber	9	.75 (19.05)	.25 (6.35)	.90 (22.86)	.375 (9.53)	9.00 (228.60)
DAT-129-658-1,-10	1,000/10,000	Polyimide	Amber	9	.75 (19.05)	.25 (6.35)	.90 (22.86)	.375 (9.53)	9.00 (228.60)
DAT-130-164-1,-10	1,000/10,000	Polyester	Silver	9	.75 (19.05)	.25 (6.35)	.90 (22.86)	.375 (9.53)	9.00 (228.60)
.80" Label Width — 6 or 8 lines per inch									
DAT-5-499-1,-10	1,000/10,000	Nylon Cloth	White	6	.80 (20.32)	1.437 (36.50)	.90 (22.86)	1.50 (38.10)	6.30 (160.02)
DAT-5-502-1,-10	1,000/10,000	Vinyl Cloth	White	6	.80 (20.32)	1.437 (36.50)	.90 (22.86)	1.50 (38.10)	6.30 (160.02)
DAT-6-632-1,-10	1,000/10,000	Polyvinylfluoride	White	6	.80 (20.32)	1.437 (36.50)	.90 (22.86)	1.50 (38.10)	6.30 (160.02)
.80" Label Width — 6 or 8 lines per inch — Square Corners									
DAT-146-502-1,-10	1,000/10,000	Vinyl Cloth	White	10	.80 (20.32)	.937 (23.80)	.80 (20.32)	1.00 (25.40)	9.00 (228.60)
DAT-147-632-1,-10	1,000/10,000	Polyvinylfluoride	White	10	.80 (20.32)	.937 (23.80)	.80 (20.32)	1.00 (25.40)	9.00 (228.60)
.90" Label Width — 6 lines per inch									
DAT-49-637-1,-10	1,000/10,000	Polyvinylfluoride	White	8	.90 (22.86)	.25 (6.35)	1.00 (25.40)	.33 (8.46)	8.90 (226.06)
DAT-50-652-1,-10	1,000/10,000	Polyimide	Amber	8	.90 (22.86)	.25 (6.35)	1.00 (25.40)	.33 (8.46)	8.90 (226.06)
DAT-60-619-1,-10	1,000/10,000	Polyester	White	8	.90 (22.86)	.25 (6.35)	1.00 (25.40)	.33 (8.46)	8.90 (226.06)
DAT-120-164-1,-10	1,000/10,000	Polyester	Silver	8	.90 (22.86)	.25 (6.35)	1.00 (25.40)	.33 (8.46)	8.90 (226.06)
DAT-1-637*-1,-10	1,000/10,000	Polyvinylfluoride	White	10	.90 (22.86)	.25 (6.35)	1.00 (25.40)	.33 (8.46)	10.90 (276.86)
.90" Label Width — 8 lines per inch									
DAT-132-637-1,-10	1,000/10,000	Polyvinylfluoride	White	8	.90 (22.86)	.25 (6.35)	1.00 (25.40)	.375 (9.53)	8.90 (226.06)
DAT-133-652-1,-10	1,000/10,000	Polyimide	Amber	8	.90 (22.86)	.25 (6.35)	1.00 (25.40)	.375 (9.53)	8.90 (226.06)
DAT-134-619-1,-10	1,000/10,000	Polyester	White	8	.90 (22.86)	.25 (6.35)	1.00 (25.40)	.375 (9.53)	8.90 (226.06)
DAT-135-164-1,-10	1,000/10,000	Polyester	Silver	8	.90 (22.86)	.25 (6.35)	1.00 (25.40)	.375 (9.53)	8.90 (226.06)

RF=These parts are supplied on a three inch core for those applications requiring a rollform feed mechanism into the printer. The parts are shipped with a 48 hour lead time.

*Size does not fit narrow carriage (80-column) printers. See p. 141 for identical narrow carriage labels.

Note: Labels in chart are sorted in order by width, height, 3 digit material number (within part number), then die number (within part number).

LASER, INK JET & DOT MATRIX LABELS

DOT MATRIX LABELS INDEX BY SIZE

Labels Index by Size

CONTINUED

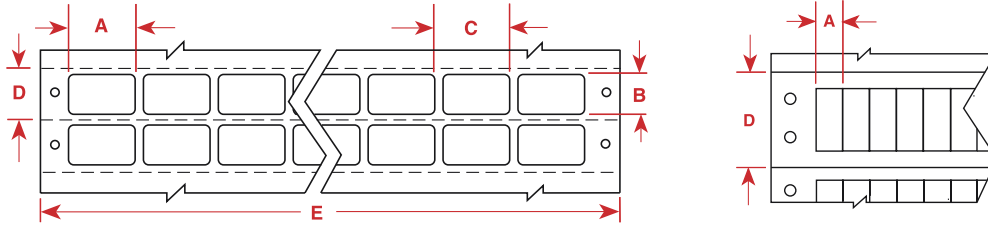

Part Number	Pieces Per Package	Material	Color	Labels Per Row	Label Width Inch (mm) A	Label Height Inch (mm) B	Horizontal Repeat Inch (mm) C	Vertical Repeat Inch (mm) D	Web Width Inch (mm) E
1.00" Label Width — 6 lines per inch									
DAT-18-129-1,-10	1,000/10,000	Paper	White	7	1.00 (25.40)	.50 (12.70)	1.10 (27.94)	.667 (16.94)	8.60 (218.44)
DAT-18-499-1,-10	1,000/10,000	Nylon Cloth	White	7	1.00 (25.40)	.50 (12.70)	1.10 (27.94)	.667 (16.94)	8.60 (218.44)
DAT-18-502-1,-10	1,000/10,000	Vinyl Cloth	White	7	1.00 (25.40)	.50 (12.70)	1.10 (27.94)	.667 (16.94)	8.60 (218.44)
DAT-18-502-1,-10-RF	1,000/10,000	Vinyl Cloth	White	7	1.00 (25.40)	.50 (12.70)	1.10 (27.94)	.667 (16.94)	8.60 (218.44)
DAT-19-607-1,-10	1,000/10,000	Tamper-Resistant Vinyl	White	7	1.00 (25.40)	.50 (12.70)	1.10 (27.94)	.667 (16.94)	8.60 (218.44)
DAT-20-619-1,-10	1,000/10,000	Polyester	White	7	1.00 (25.40)	.50 (12.70)	1.10 (27.94)	.667 (16.94)	8.60 (218.44)
DAT-47-693-1,-10	1,000/10,000	Metallized Polyester	Silver	7	1.00 (25.40)	.50 (12.70)	1.10 (27.94)	.667 (16.94)	8.60 (218.44)
DAT-47-969-1,-10	1,000/10,000	Metallized Polyester	Silver	7	1.00 (25.40)	.50 (12.70)	1.10 (27.94)	.667 (16.94)	8.60 (218.44)
DAT-57-637-1,-10	1,000/10,000	Polyvinylfluoride	White	7	1.00 (25.40)	.50 (12.70)	1.10 (27.94)	.667 (16.94)	8.60 (218.44)
DAT-59-652-1,-10	1,000/10,000	Polyimide	Amber	7	1.00 (25.40)	.50 (12.70)	1.10 (27.94)	.667 (16.94)	8.60 (218.44)
DAT-97-673-1,-10	1,000/10,000	Polyester	White	7	1.00 (25.40)	.50 (12.70)	1.10 (27.94)	.667 (16.94)	8.60 (218.44)
DAT-99-637-1,-10	1,000/10,000	Polyvinylfluoride	Yellow	7	1.00 (25.40)	.50 (12.70)	1.10 (27.94)	.667 (16.94)	8.60 (218.44)
DAT-163-621-1,-10	1,000/10,000	Polyester	Clear	7	1.00 (25.40)	.50 (12.70)	1.10 (27.94)	.667 (16.90)	8.60 (218.44)
DAT-181-619-1	1,000/10,000	Polyester	White	7	1.00 (25.40)	.25 (6.35)	1.10 (27.94)	.333 (8.46)	8.60 (218.44)
DAT-181-652-1	1,000	Polyimide	Amber	7	1.00 (25.40)	.25 (6.35)	1.10 (27.94)	.333 (8.46)	8.60 (218.44)
1.00" Label Width — 6 or 8 lines per inch									
DAT-11-499-1,-10	1,000/10,000	Nylon Cloth	White	7	1.00 (25.40)	.375 (9.53)	1.10 (27.94)	.50 (12.70)	8.60 (218.44)
DAT-11-502-1,-10	1,000/10,000	Vinyl Cloth	White	7	1.00 (25.40)	.375 (9.53)	1.10 (27.94)	.50 (12.70)	8.60 (218.44)
DAT-11-502-10-RF	10,000	Vinyl Cloth	White	7	1.00 (25.40)	.375 (9.53)	1.10 (27.94)	.50 (12.70)	8.60 (218.44)
DAT-51-619-1,-10	1,000/10,000	Polyester	White	7	1.00 (25.40)	.375 (9.53)	1.10 (27.94)	.50 (12.70)	8.60 (218.44)
DAT-83-502-1,-10	1,000/10,000	Vinyl Cloth	White	7	1.00 (25.40)	.75 (19.05)	1.10 (27.94)	1.00 (25.40)	8.60 (218.44)
DAT-84-632-1,-10	1,000/10,000	Polyvinylfluoride	White	7	1.00 (25.40)	.75 (19.05)	1.10 (27.94)	1.00 (25.40)	8.60 (218.44)
1.00" Label Width — 6 or 8 lines per inch — Square Corners									
DAT-149-502-1,-10	1,000/10,000	Vinyl Cloth	White	8	1.00 (25.40)	.937 (23.80)	1.00 (25.40)	1.00 (25.40)	9.00 (228.60)
DAT-150-632-1,-10	1,000/10,000	Polyvinylfluoride	White	8	1.00 (25.40)	.937 (23.80)	1.00 (25.40)	1.00 (25.40)	9.00 (228.60)
1.125" Label Width — 8 lines per inch									
DAT-160-502-1,-10	1,000/10,000	Vinyl Cloth	White	4	1.125 (28.58)	.530 (13.46)	1.60 (40.64)	.625 (15.88)	7.30 (185.42)
1.25" Label Width — 6 or 8 lines per inch									
DAT-72-637-1,-10	1,000/10,000	Polyvinylfluoride	Yellow	5	1.25 (31.75)	.375 (9.53)	1.40 (35.56)	.50 (12.70)	7.95 (201.93)
DAT-73-637-1,-10	1,000/10,000	Polyvinylfluoride	White	5	1.25 (31.75)	.375 (9.53)	1.40 (35.56)	.50 (12.70)	7.95 (201.93)
DAT-74-637-1,-10	1,000/10,000	Polyvinylfluoride	Gray	5	1.25 (31.75)	.375 (9.53)	1.40 (35.56)	.50 (12.70)	7.95 (201.93)
DAT-2-637*-1,-10	1,000/10,000	Polyvinylfluoride	Yellow	7	1.25 (31.75)	.375 (9.53)	1.40 (35.56)	.50 (12.70)	10.75 (273.05)
DAT-10-637*-1,-10	1,000/10,000	Polyvinylfluoride	White	7	1.25 (31.75)	.375 (9.53)	1.40 (35.56)	.50 (12.70)	10.75 (273.05)
DAT-23-637*-1,-10	1,000/10,000	Polyvinylfluoride	Gray	7	1.25 (31.75)	.375 (9.53)	1.40 (35.56)	.50 (12.70)	10.75 (273.05)
DAT-182-502-1	1,000	Vinyl Cloth	White	5	1.25 (31.75)	.375 (9.53)	1.40 (35.56)	.50 (12.70)	7.90 (200.66)
1.50" Label Width — 8 lines per inch									
BCDAT-8-619-1,-5	1,000/5,000	Polyester	White	4	1.50 (38.10)	.25 (6.35)	1.60 (40.64)	.375 (9.53)	7.30 (185.42)
BCDAT-8-652-1,-5	1,000/5,000	Polyimide	Amber	4	1.50 (38.10)	.25 (6.35)	1.60 (40.64)	.375 (9.53)	7.30 (185.42)

RF=These parts are supplied on a three inch core for those applications requiring a rollform feed mechanism into the printer. The parts are shipped with a 48 hour lead time.

*Size does not fit narrow carriage (80-column) printers. See p. 141 for identical narrow carriage labels.

Note: Labels in chart are sorted in order by width, height, 3 digit material number (within part number), then die number (within part number).

Labels Index by Size

CONTINUED

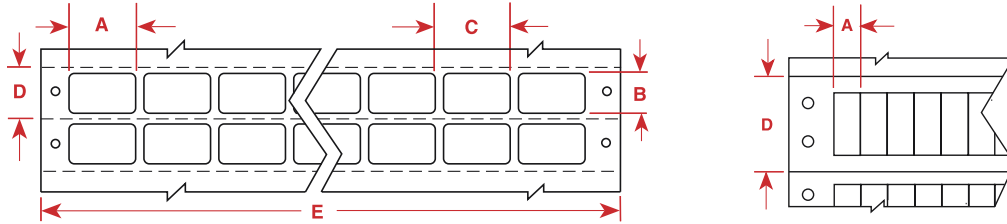

Part Number	Pieces Per Package	Material	Color	Labels Per Row	Label Width Inch A	Label Height Inch B	Horizontal Repeat Inch C	Vertical Repeat Inch D	Web Width Inch E
1.60" Label Width — 8 lines per inch									
DAT-170-969-1,-10	1,000/10,000	Polyester	Silver	4	1.60 (40.64)	.375 (9.53)	1.70 (43.18)	.50 (12.70)	7.70 (195.58)
2.00" Label Width — 6 or 8 lines per inch									
BCDAT-10-619-1,-10	1,000/10,000	Polyester	White	3	2.00 (50.80)	.375 (9.53)	2.10 (53.34)	.50 (12.70)	7.20 (182.88)
BCDAT-10-652-1,-10	1,000/10,000	Polyimide	Amber	3	2.00 (50.80)	.375 (9.53)	2.10 (53.34)	.50 (12.70)	7.20 (182.88)
DAT-64-502-1,-10	1,000/10,000	Vinyl Cloth	White	3	2.00 (50.80)	.375 (9.53)	2.10 (53.34)	.50 (12.70)	7.20 (182.88)
DAT-12-502*-1,-10	1,000/10,000	Vinyl Cloth	White	4	2.00 (50.80)	.375 (9.53)	2.10 (53.34)	.50 (12.70)	9.30 (236.22)
BCDAT-1-609-1,-5	1,000/5,000	Litho Paper	White	3	2.00 (50.80)	.90 (22.86)	2.10 (53.34)	1.00 (25.40)	7.20 (182.88)
BCDAT-1-619-1,-5	1,000/5,000	Polyester	White	3	2.00 (50.80)	.90 (22.86)	2.10 (53.34)	1.00 (25.40)	7.20 (182.88)
DAT-77-969-1,-5	1,000/5,000	Metallized Polyester	Silver	3	2.00 (50.80)	.90 (22.86)	2.10 (53.34)	1.00 (25.40)	7.20 (182.88)
BCDAT-3-609-1,-5	1,000/5,000	Litho Paper	White	3	2.00 (50.80)	1.437 (36.50)	2.10 (53.34)	1.50 (38.10)	7.20 (182.88)
BCDAT-3-619-1,-5	1,000/5,000	Polyester	White	3	2.00 (50.80)	1.437 (36.50)	2.10 (53.34)	1.50 (38.10)	7.20 (182.88)
DAT-79-969-1,-5	1,000/5,000	Metallized Polyester	Silver	3	2.00 (50.80)	1.437 (36.50)	2.10 (53.34)	1.50 (38.10)	7.20 (182.88)
2.00" Label Width — 8 lines per inch									
BCDAT-9-619-1,-5	1,000/5,000	Polyester	White	3	2.00 (50.80)	.25 (6.35)	2.10 (53.34)	.375 (9.53)	7.20 (182.88)
BCDAT-9-652-1,-5	1,000/5,000	Polyimide	Amber	3	2.00 (50.80)	.25 (6.35)	2.10 (53.34)	.375 (9.53)	7.20 (182.88)
3.00" Label Width — 6 or 8 lines per inch									
BCDAT-11-619-1,-10	1,000/10,000	Polyester	White	2	3.00 (76.20)	.375 (9.53)	3.10 (78.74)	.50 (12.70)	7.10 (180.34)
BCDAT-11-652-1,-10	1,000/10,000	Polyimide	Amber	2	3.00 (76.20)	.375 (9.53)	3.10 (78.74)	.50 (12.70)	7.10 (180.34)
DAT-13-502-1,-10	1,000/10,000	Vinyl Cloth	White	2	3.00 (76.20)	.375 (9.53)	3.10 (78.74)	.50 (12.70)	7.10 (180.34)
BCDAT-2-609-1,-5	1,000/5,000	Litho Paper	White	2	3.00 (76.20)	.90 (22.86)	3.10 (78.74)	1.00 (25.40)	7.10 (180.34)
BCDAT-2-619-1,-5	1,000/5,000	Polyester	White	2	3.00 (76.20)	.90 (22.86)	3.10 (78.74)	1.00 (25.40)	7.10 (180.34)
DAT-78-969-1,-5	1,000/5,000	Metallized Polyester	Silver	2	3.00 (76.20)	.90 (22.86)	3.10 (78.74)	1.00 (25.40)	7.10 (180.34)
BCDAT-4-609-1,-5	1,000/5,000	Litho Paper	White	2	3.00 (76.20)	1.437 (36.50)	3.10 (78.74)	1.50 (38.10)	7.10 (180.34)
BCDAT-4-619-1,-5	1,000/5,000	Polyester	White	2	3.00 (76.20)	1.437 (36.50)	3.10 (78.74)	1.50 (38.10)	7.10 (180.34)
DAT-80-969-1,-5	1,000/5,000	Metallized Polyester	Silver	2	3.00 (76.20)	1.437 (36.50)	3.10 (78.74)	1.50 (38.10)	7.10 (180.34)
BCDAT-6-609-1,-5	1,000/5,000	Litho Paper	White	2	3.00 (76.20)	1.90 (48.26)	3.10 (78.74)	2.00 (50.80)	7.10 (180.34)
BCDAT-6-619-1,-5	1,000/5,000	Polyester	White	2	3.00 (76.20)	1.90 (48.26)	3.10 (78.74)	2.00 (50.80)	7.10 (180.34)
DAT-82-969-1,-5	1,000/5,000	Metallized Polyester	Silver	2	3.00 (76.20)	1.90 (48.26)	3.10 (78.74)	2.00 (50.80)	7.10 (180.34)
3.90" Label Width — 6 or 8 lines per inch									
BCDAT-5-609-1,-5	1,000/5,000	Litho Paper	White	2	3.90 (99.06)	1.437 (36.50)	4.00 (101.60)	1.50 (38.10)	8.90 (226.06)
BCDAT-5-619-1,-5	1,000/5,000	Polyester	White	2	3.90 (99.06)	1.437 (36.50)	4.00 (101.60)	1.50 (38.10)	8.90 (226.06)
DAT-81-969-1,-5	1,000/5,000	Metallized Polyester	Silver	2	3.90 (99.06)	1.437 (36.50)	4.00 (101.60)	1.50 (38.10)	8.90 (226.06)
4.00" Label Width — 6 or 8 lines per inch									
DAT-180-609-1	1,000	Litho Paper	White	2	4.00 (101.60)	2.00 (50.80)	4.10 (104.14)	2.17 (55.12)	9.10 (231.14)

Note: Labels in chart are sorted in order by width, height, 3 digit material number (within part number), then die number (within part number).

LASER, INK JET & DOT MATRIX LABELS

DOT MATRIX LABELS INDEX BY SIZE

Labels Index by Size

CONTINUED

LASER, INK JET & DOT MATRIX LABELS

BUTT-CUT WITH PERFORATIONS Square Corners

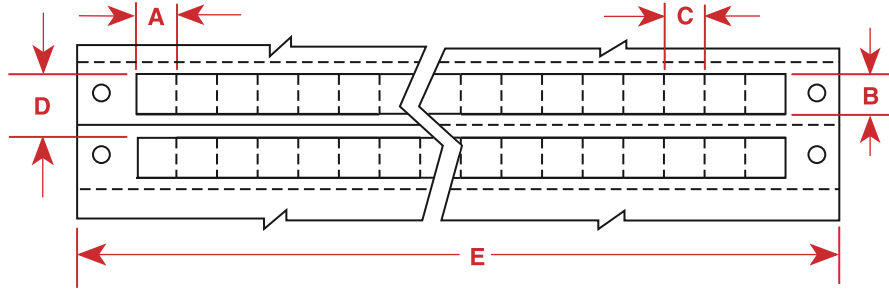

Part Number	Pieces Per Package	Material	Color	Labels Per Row	Label Width Inch (mm) A	Label Height Inch (mm) B	Horizontal Repeat Inch (mm) C	Vertical Repeat Inch (mm) D	Web Width Inch (mm) E
.30" Label Width — 6 or 8 lines per inch									
DAT-106-652-1,-10	1,000/10,000	Polyimide	Amber	16	.30 (7.62)	.30 (7.62)	.30 (7.62)	.50 (12.70)	5.80 (147.32)
DAT-107-658-1,-10	1,000/10,000	Polyimide	Amber	16	.30 (7.62)	.30 (7.62)	.30 (7.62)	.50 (12.70)	5.80 (147.32)
DAT-108-619-1,-10	1,000/10,000	Polyester	White	16	.30 (7.62)	.30 (7.62)	.30 (7.62)	.50 (12.70)	5.80 (147.32)
.80" Label Width — 6 lines per inch									
DAT-101-652-1,-10	1,000/10,000	Polyimide	Amber	10	.80 (20.32)	.20 (5.08)	.80 (20.32)	.33 (8.46)	9.00 (228.60)
DAT-102-619-1,-10	1,000/10,000	Polyester	White	10	.80 (20.32)	.20 (5.08)	.80 (20.32)	.33 (8.46)	9.00 (228.60)

Note: Labels in chart are sorted in order by width, height, 3 digit material number (within part number), then die number (within part number).

BUTT-CUT WITH PERFORATIONS Rounded Corners

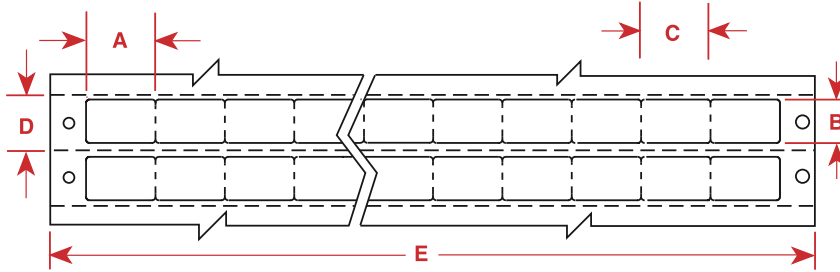

Part Number	Pieces Per Package	Material	Color	Labels Per Row	Label Width Inch (mm) A	Label Height Inch (mm) B	Horizontal Repeat Inch (mm) C	Vertical Repeat Inch (mm) D	Web Width Inch (mm) E
.25" Label Width — 8 lines per inch									
DAT-172-652-1,-10	1,000/10,000	Polyimide	Amber	20	.25 (6.35)	.25 (6.35)	.25 (6.35)	.50 (12.70)	6.00 (152.40)
DAT-173-619-1,-10	1,000/10,000	Polyester	White	20	.25 (6.35)	.25 (6.35)	.25 (6.35)	.50 (12.70)	6.00 (152.40)
.80" Label Width — 8 lines per inch									
DAT-103-652-1,-10	1,000/10,000	Polyimide	Amber	10	.80 (20.32)	.50 (12.70)	.80 (20.32)	.625 (15.88)	9.00 (228.60)
DAT-104-619-1,-10	1,000/10,000	Polyester	White	10	.80 (20.32)	.50 (12.70)	.80 (20.32)	.625 (15.88)	9.00 (228.60)
DAT-105-110-1,-10	1,000/10,000	Paper	White	10	.80 (20.32)	.50 (12.70)	.80 (20.32)	.625 (15.88)	9.00 (228.60)

Note: Labels in chart are sorted in order by width, height, 3 digit material number (within part number), then die number (within part number).

DOT MATRIX LABELS INDEX BY SIZE

Labels Index by Size

CONTINUED

▶ SLIT LINER for easy removal

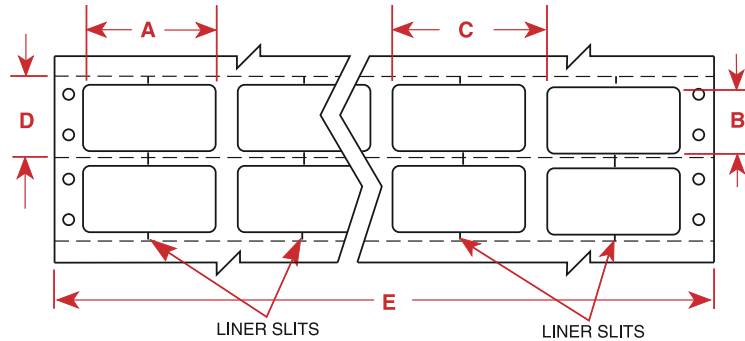

Part Number	Pieces Per Package	Material	Color	Labels Per Row	Label Width Inch (mm) A	Label Height Inch (mm) B	Horizontal Repeat Inch (mm) C	Vertical Repeat Inch (mm) D	Web Width Inch (mm) E
1.50" Label Width — 6 or 8 lines per inch									
BCDAT-12-619-1,-10	1,000/10,000	Polyester	White	4	1.50 (38.10)	.75 (19.05)	1.70 (43.18)	1.00 (25.40)	7.60 (193.04)
DAT-3-637-1,-10	1,000/10,000	Polyvinylfluoride	White	4	1.50 (38.10)	.75 (19.05)	1.70 (43.18)	1.00 (25.40)	7.60 (193.04)
DAT-4-637-1,-10	1,000/10,000	Polyvinylfluoride	Yellow	4	1.50 (38.10)	.75 (19.05)	1.70 (43.18)	1.00 (25.40)	7.60 (193.04)
DAT-48-693-1,-10	1,000/10,000	Metallized Polyester	Silver	4	1.50 (38.10)	.75 (19.05)	1.70 (43.18)	1.00 (25.40)	7.60 (193.04)
DAT-48-969-1,-10	1,000/10,000	Metallized Polyester	Silver	4	1.50 (38.10)	.75 (19.05)	1.70 (43.18)	1.00 (25.40)	7.60 (193.04)

Note: Labels in chart are sorted in order by width, height, 3 digit material number (within part number), then die number (within part number).

▶ CENTER PERFORATION (VERTICAL)

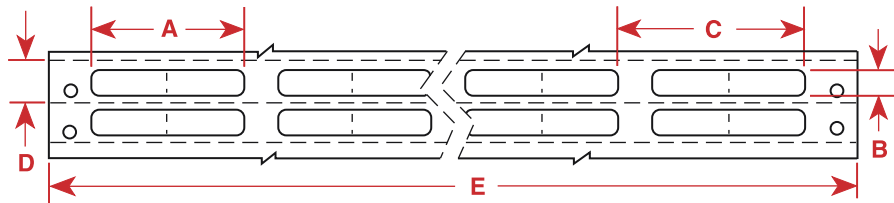

Part Number	Pieces Per Package	Material	Color	Labels Per Row	Label Width Inch (mm) A	Label Height Inch (mm) B	Horizontal Repeat Inch (mm) C	Vertical Repeat Inch (mm) D	Web Width Inch (mm) E
1.50" Label Width — 6 lines per inch									
DAT-28-121-1,-10	1,000/10,000	Paper	White	4	1.50 (38.10)	.25 (6.35)	1.80 (45.72)	.33 (8.46)	7.90 (200.66)
DAT-29-499-1,-10	1,000/10,000	Nylon Cloth	White	4	1.50 (38.10)	.25 (6.35)	1.80 (45.72)	.33 (8.46)	7.90 (200.66)
DAT-29-502-1,-10	1,000/10,000	Vinyl Cloth	White	4	1.50 (38.10)	.25 (6.35)	1.80 (45.72)	.33 (8.46)	7.90 (200.66)

Note: Labels in chart are sorted in order by width, height, 3 digit material number (within part number), then die number (within part number).

LASER, INK JET & DOT MATRIX LABELS

DOT MATRIX LABELS INDEX BY SIZE

Labels Index by Size

CONTINUED

LASER, INK JET & DOT MATRIX LABELS

CENTER PERFORATIONS (HORIZONTAL)

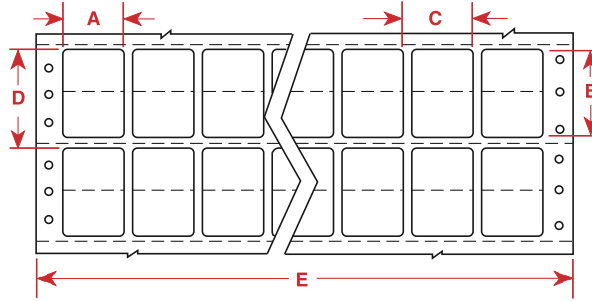

Part Number	Pieces Per Package	Material	Color	Labels Per Row	Label Width Inch (mm) A	Label Height Inch (mm) B	Horizontal Repeat Inch (mm) C	Vertical Repeat Inch (mm) D	Web Width Inch (mm) E
1.00" Label Width — 6 or 8 lines per inch									
DAT-86-502-1,-10	1,000/10,000	Vinyl Cloth	White	7	1.00 (25.40)	1.437 (36.50)	1.10 (27.94)	1.50 (38.10)	8.60 (218.44)
DAT-87-632-1,-10	1,000/10,000	Polyvinylfluoride	White	7	1.00 (25.40)	1.437 (36.50)	1.10 (27.94)	1.50 (38.10)	8.60 (218.44)

Note: Labels in chart are sorted in order by width, height, 3 digit material number (within part number), then die number (within part number).

TAMPER-RESISTANT SLITS

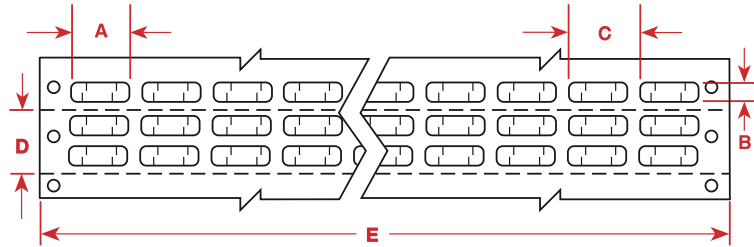

Part Number	Pieces Per Package	Material	Color	Labels Per Row	Label Width Inch (mm) A	Label Height Inch (mm) B	Horizontal Repeat Inch (mm) C	Vertical Repeat Inch (mm) D	Web Width Inch (mm) E
.65" Label Width — 8 lines per inch									
DAT-90-619-1,-10	1,000/10,000	Polyester	White	10	.65 (16.51)	.20 (5.08)	.80 (20.32)	.25 (6.35)	8.85 (224.80)
DAT-91-652-1,-10	1,000/10,000	Polyimide	Amber	10	.65 (16.51)	.20 (5.08)	.80 (20.32)	.25 (6.35)	8.85 (224.80)
.75" Label Width — 6 lines per inch									
DAT-92-619-1,-10	1,000/10,000	Polyester	White	9	.75 (19.05)	.25 (6.35)	.90 (22.86)	.33 (8.46)	9.00 (228.60)
DAT-93-652-1,-10	1,000/10,000	Polyimide	Amber	9	.75 (19.05)	.25 (6.35)	.90 (22.86)	.33 (8.46)	9.00 (228.60)
.90" Label Width — 6 lines per inch									
DAT-94-652-1,-10	1,000/10,000	Polyimide	Amber	8	.90 (22.86)	.25 (6.35)	1.00 (25.40)	.33 (8.46)	8.90 (226.06)
DAT-95-619-1,-10	1,000/10,000	Polyester	White	8	.90 (22.86)	.25 (6.35)	1.00 (25.40)	.33 (8.46)	8.90 (226.06)

Note: Labels in chart are sorted in order by width, height, 3 digit material number (within part number), then die number (within part number).

DOT MATRIX LABELS INDEX BY SIZE

Labels Index by Size

CONTINUED

LASER, INK JET & DOT MATRIX LABELS

HORIZONTAL SLIT

Wire marker with matching terminal block marker

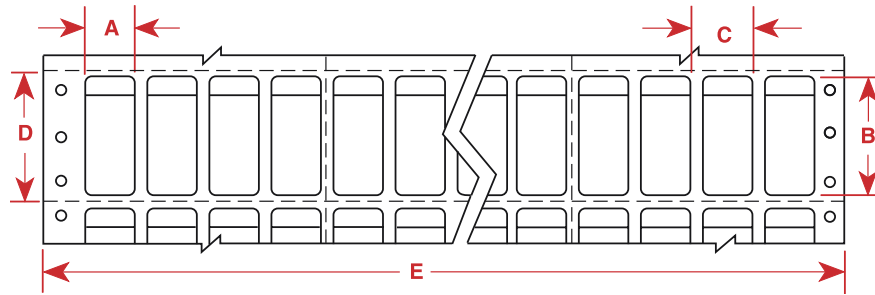

Part Number	Pieces Per Package	Material	Color	Labels Per Row	Label Width Inch (mm) A	Label Height Inch (mm) B	Horizontal Repeat Inch (mm) C	Vertical Repeat Inch (mm) D	Web Width Inch (mm) E
.50" Label Width — 6 or 8 lines per inch									
DAT-76-502-1,-10	1,000/10,000	Vinyl Cloth	White	12	.50 (12.70)	1437 (36.50)	.60 (15.24)	1.50 (38.10)	8.10 (205.74)

Note: Labels in chart are sorted in order by width, height, 3 digit material number (within part number), then die number (within part number).

1/16" BLACK BORDER

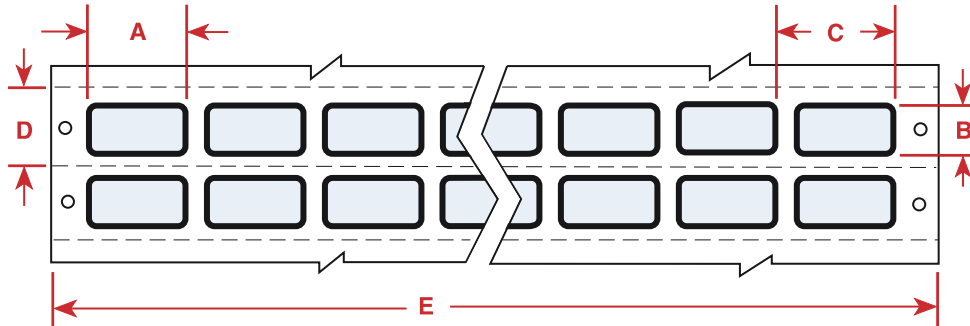

Part Number	Pieces Per Package	Material	Color	Labels Per Row	Label Width Inch (mm) A	Label Height Inch (mm) B	Horizontal Repeat Inch (mm) C	Vertical Repeat Inch (mm) D	Web Width Inch (mm) E
1.00" Label Width — 6 lines per inch									
DAT-164-969-BK-1,-10	1,000/10,000	Polyester	Silver	7	1.00 (25.40)	.50 (12.70)	1.10 (27.94)	.67 (17.02)	8.60 (218.44)
1.63" Label Width — 6 or 8 lines per inch									
DAT-183-969-BK-1	1,000	Polyester	Silver	4	1.63 (41.40)	.75 (19.05)	1.73 (43.94)	1.00 (25.40)	7.82 (198.63)
2.00" Label Width — 6 or 8 lines per inch									
DAT-184-969-BK-1	1,000	Polyester	Silver	3	2.00 (50.80)	1.00 (25.40)	2.10 (53.34)	1.50 (38.10)	7.20 (182.88)

Note: Labels in chart are sorted in order by width, height, 3 digit material number (within part number), then die number (within part number).

DOT MATRIX LABELS INDEX BY SIZE

Labels Index by Size

CONTINUED

LASER, INK JET & DOT MATRIX LABELS

STATIC AWARENESS LABELS for EPROM marking

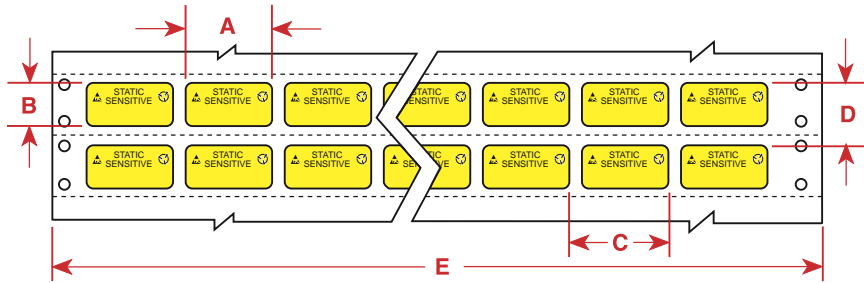

Part Number	Pieces Per Package	Material	Color	Printable Area In. (mm)	Label Width Inch (mm) A	Label Height Inch (mm) B	Horizontal Repeat Inch (mm) C	Vertical Repeat Inch (mm) D	Web Width Inch (mm) E
1.00" Label Width — 6 or 8 lines per inch									
SLDAT-1-502-1,-10	1,000/10,000	Vinyl Cloth on Yellow	Black (25.40 x 7.92)	1.00 x .312	1.00 (25.40)	.50 (12.70)	1.10 (27.94)	67 (1702)	8.60 (218.44)
SLDAT-1-619-1,-10	1,000/10,000	Polyester	Black on Yellow/White (25.40 x 7.92)	1.00 x .312	1.00 (25.40)	.50 (12.70)	1.10 (27.94)	67 (1702)	8.60 (218.44)

Note: Labels in chart are sorted in order by width, height, 3 digit material number (within part number), then die number (within part number).

Permashield™ Markers

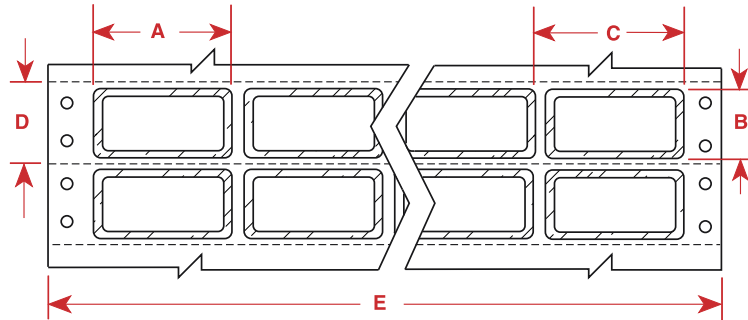

Clear polyester (B-966) overlaminates extends .125 outside of label on each side.

Part Number	Pieces Per Package	Material	Color	Labels Per Row	Label Width Inch (mm) A	Label Height Inch (mm) B	Horizontal Repeat Inch (mm) C	Vertical Repeat Inch (mm) D	Web Width Inch (mm) E
1.00" Label Width — 6 or 8 lines per inch									
PSL-1-609-1,-5	1,000/5,000	Paper	White	6	1.00 (25.40)	.50 (12.70)	1.40 (35.56)	1.00 (25.40)	9.25 (234.95)
PSL-1-619-1,-5	1,000/5,000	Polyester	White	6	1.00 (25.40)	.50 (12.70)	1.40 (35.56)	1.00 (25.40)	9.25 (234.95)
PSL-1-969-1,-5	1,000/5,000	Metallized Polyester	Silver	6	1.00 (25.40)	.50 (12.70)	1.40 (35.56)	1.00 (25.40)	9.25 (234.95)
1.50" Label Width — 6 or 8 lines per inch									
PSL-2-609-1,-5	1,000/5,000	Paper	White	4	1.50 (38.10)	.75 (19.05)	1.90 (48.26)	1.50 (38.10)	8.45 (214.63)
PSL-2-619-1,-5	1,000/5,000	Polyester	White	4	1.50 (38.10)	.75 (19.05)	1.90 (48.26)	1.50 (38.10)	8.45 (214.63)
PSL-2-969-1,-5	1,000/5,000	Metallized Polyester	Silver	4	1.50 (38.10)	.75 (19.05)	1.90 (48.26)	1.50 (38.10)	8.45 (214.63)
2.00" Label Width — 6 or 8 lines per inch									
PSL-3-609-1,-5	1,000/5,000	Paper	White	3	2.00 (50.80)	1.00 (25.40)	2.40 (60.96)	1.50 (38.10)	8.05 (204.47)
PSL-3-619-1,-5	1,000/5,000	Polyester	White	3	2.00 (50.80)	1.00 (25.40)	2.40 (60.96)	1.50 (38.10)	8.05 (204.47)
PSL-3-969-1,-5	1,000/5,000	Metallized Polyester	Silver	3	2.00 (50.80)	1.00 (25.40)	2.40 (60.96)	1.50 (38.10)	8.05 (204.47)

Note: Labels in chart are sorted in order by width, height, 3 digit material number (within part number), then die number (within part number).

DOT MATRIX LABELS INDEX BY SIZE

Terminal Block Markers by Size

LASER, INK JET & DOT MATRIX LABELS

ONE-ACROSS

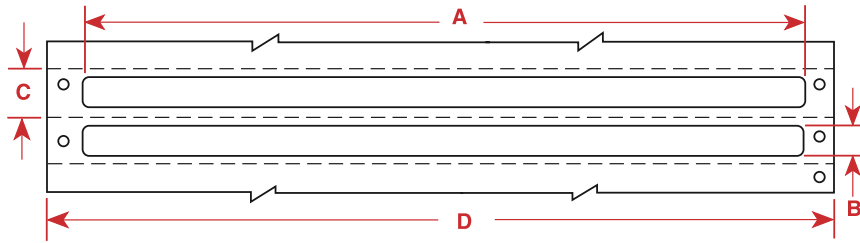

Part Number	Pieces Per Package	Material	Color	Labels Per Row	Label Width Inch (mm) A	Label Height Inch (mm) B	Vertical Repeat Inch (mm) C	Web Width Inch (mm) D
6.00" Label Width — 6 or 8 lines per inch								
BCDAT-7-609-1,-2.5	1,000/2,500	Litho Paper	White	1	6.00 (152.40)	3.937 (100.00)	4.00 (101.60)	7.00 (177.80)
8.00" Label Width — 6 or 8 lines per inch								
DAT-165-502-1,-2.5	1,000/2,500	Vinyl Cloth	White	1	8.00 (203.20)	.281 (7.14)	.50 (12.70)	9.00 (228.60)
DAT-166-502-1,-2.5	1,000/2,500	Vinyl Cloth	White	1	8.00 (203.20)	.312 (7.92)	.50 (12.70)	9.00 (228.60)
DAT-167-502-1,-2.5	1,000/2,500	Vinyl Cloth	White	1	8.00 (203.20)	.375 (9.53)	.50 (12.70)	9.00 (228.60)

Note: Labels in chart are sorted in order by width, height, 3 digit material number (within part number), then die number (within part number).

CONTINUOUS STRIP/ONE-ACROSS

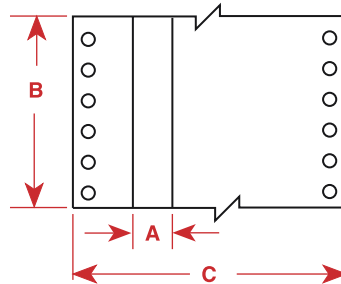

Part Number	Inches Per Package	Material	Color	Strips Per Row	Label Width Inch (mm) A	Label Height Inch (mm) B	Web Width Inch (mm) C
.281" Label Width — 6 or 8 lines per inch							
DAT-156-502-2	2,000"	Vinyl Cloth	White	1	.281 (7.14)	Continuous	3.50 (88.90)
.312" Label Width — 6 or 8 lines per inch							
DAT-157-502-2	2,000"	Vinyl Cloth	White	1	.312 (7.92)	Continuous	3.50 (88.90)
.375" Label Width — 6 or 8 lines per inch							
DAT-158-502-2	2,000"	Vinyl Cloth	White	1	.375 (9.53)	Continuous	3.50 (88.90)

Note: Labels in chart are sorted in order by width, height, 3 digit material number (within part number), then die number (within part number).

DOT MATRIX MARKERS INDEX BY SIZE

Terminal Block Markers by Size

CONTINUED

LASER, INK JET & DOT MATRIX LABELS

CONTINUOUS STRIP/MULTIPLE ACROSS

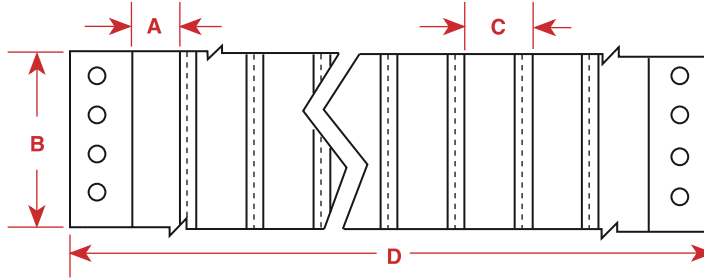

Part Number	Inches Per Package	Material	Color	Labels Per Row	Label Width In. (mm) A	Label Height In. (mm) B	Horizontal Repeat In. (mm) C	Web Width In. (mm) D
.312" Label Width — 6 or 8 lines per inch								
DAT-153-502-2,-7	2,000"/7,000"	Vinyl Cloth	White	10	.312 (7.92)	Continuous	.50 (12.70)	5.00 (127.00)
.375" Label Width — 6 or 8 lines per inch								
DAT-100-502-2,-7	2,000"/7,000"	Vinyl Cloth	White	8	.375 (9.53)	Continuous	.50 (12.70)	5.00 (127.00)

Note: Labels in chart are sorted in order by width, height, 3 digit material number (within part number), then die number (within part number).

CONTINUOUS STRIP/PERFORATED

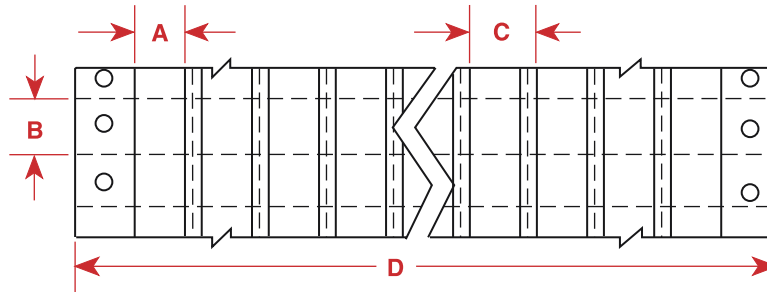

Part Number	Inches Per Package	Material	Color	Labels Per Row	Label Width In. (mm) A	Label Height In. (mm) B	Horizontal Repeat In. (mm) C	Web Width In. (mm) D
.281" Label Width — 8 lines per inch								
DAT-152-502-2,-7	2,000"/7,000"	Vinyl Cloth	White	10	.281 (7.14)	.25 (6.35)	40 (10.16)	5.00 (127.00)
.312" Label Width — 8 lines per inch								
DAT-154-502-2,-7	2,000"/7,000"	Vinyl Cloth	White	10	.312 (7.92)	.375 (9.53)	40 (10.16)	5.00 (127.00)
.312" Label Width — 6 or 8 lines per inch								
DAT-155-502-2,-7	2,000"/7,000"	Vinyl Cloth	White	10	.312 (7.92)	.50 (12.70)	.50 (12.70)	5.00 (127.00)
.375" Label Width — 8 lines per inch								
DAT-168-619-2	2,000"	Polyester	White	1	.375 (9.53)	.20 (5.08)	NA	3.50 (88.90)

Note: Labels in chart are sorted in order by width, height, 3 digit material number (within part number), then die number (within part number).

DOT MATRIX MARKERS INDEX BY SIZE

Terminal Block Markers by Size

CONTINUED

▶ BUTT-CUT TRANSLUCENT

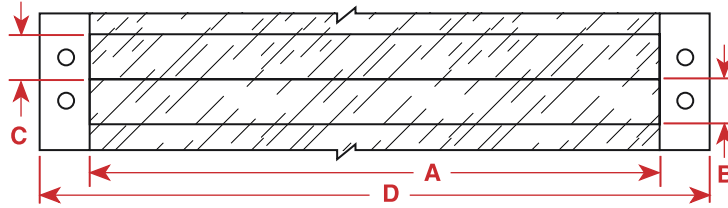

Part Number	Pieces Per Package	Material	Color	Labels Per Row	Label Width In. (mm) A	Label Height In. (mm) B	Vertical Repeat In. (mm) C	Web Width In. (mm) D
7.50" Label Width — 6 or 8 lines per inch								
DAT-169-621-1,-2,5	1,000/2,500	Polyester	Clear	1	7.50 (190.50)	.50 (12.70)	.50 (12.70)	8.62 (218.95)

Note: Labels in chart are sorted in order by width, height, 3 digit material number (within part number), then die number (within part number).

▶ PREPRINTED/PERFORATED

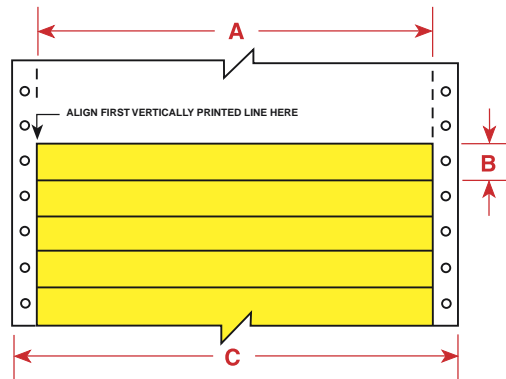

Part Number	Pieces Per Package	Material	Color	Strips Per Row	Strip Width In. (mm) A	Strip Height In. (mm) B	Web Width In. (mm) C
7.90" Label Width — 6 or 8 lines per inch							
DAT-177-124-BL	150	Paper	Blue	1	7.90 (200.66)	.475 (12.07)	8.875 (225.43)
DAT-177-124-BR	150	Paper	Brown	1	7.90 (200.66)	.475 (12.07)	8.875 (225.43)
DAT-177-124-GR	150	Paper	Green	1	7.90 (200.66)	.475 (12.07)	8.875 (225.43)
DAT-177-124-GY	150	Paper	Gray	1	7.90 (200.66)	.475 (12.07)	8.875 (225.43)
DAT-177-124-OR	150	Paper	Orange	1	7.90 (200.66)	.475 (12.07)	8.875 (225.43)
DAT-177-124-PL	150	Paper	Purple	1	7.90 (200.66)	.475 (12.07)	8.875 (225.43)
DAT-177-124-RD	150	Paper	Red	1	7.90 (200.66)	.475 (12.07)	8.875 (225.43)
DAT-177-124-WT	150	Paper	White	1	7.90 (200.66)	.475 (12.07)	8.875 (225.43)
DAT-177-124-YL	150	Paper	Yellow	1	7.90 (200.66)	.475 (12.07)	8.875 (225.43)

Note: Labels in chart are sorted in order by width, height, 3 digit material number (within part number), then die number (within part number).

LASER, INK JET & DOT MATRIX LABELS

DOT MATRIX MARKERS INDEX BY SIZE

Self-Laminating Wire and Cable Markers by Size

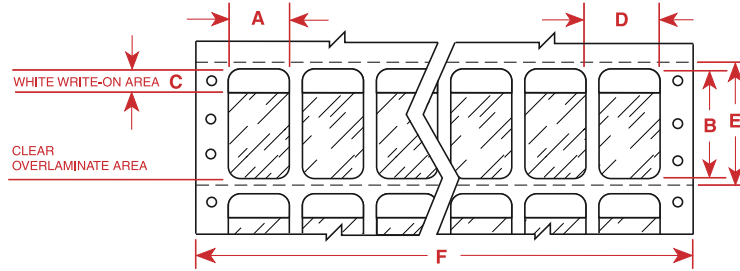

LASER, INK JET & DOT MATRIX LABELS

Part Number	Pieces Per Package	Material	Labels Per Row	Label Width In. (mm) A	Label Height In. (mm) B	Write-On Height In. (mm) C	Horizontal Repeat In. (mm) D	Vertical Repeat In. (mm) E	Web Width In. (mm) F
.50" Label Width — 6 or 8 lines per inch									
DAT-30-292*-1,-10	1,000/10,000	Vinyl	14	.50 (12.70)	.75 (19.05)	.375 (9.53)	.60 (15.24)	1.00 (25.40)	9.30 (236.22)
DAT-66-292-1,-10	1,000/10,000	Vinyl	12	.50 (12.70)	.75 (19.05)	.375 (9.53)	.60 (15.24)	1.00 (25.40)	8.10 (205.74)
DAT-71-642-1,-10	1,000/10,000	Polyvinylfluoride	12	.50 (12.70)	.75 (19.05)	.375 (9.53)	.60 (15.24)	1.00 (25.40)	8.10 (205.74)
DAT-55-642*-1,-10	1,000/10,000	Polyvinylfluoride	14	.50 (12.70)	.75 (19.05)	.375 (9.53)	.60 (15.24)	1.00 (25.40)	9.30 (236.22)
.75" Label Width — 6 or 8 lines per inch									
DAT-36-292-1,-10	1,000/10,000	Vinyl	9	.75 (19.05)	1.75 (44.45)	.50 (12.70)	.90 (22.86)	2.00 (50.80)	9.00 (228.60)
.80" Label Width — 6 or 8 lines per inch									
DAT-7-292-1,-10	1,000/10,000	Vinyl	6	.80 (20.32)	1.437 (36.50)	.50 (12.70)	.90 (22.86)	1.50 (38.10)	6.30 (160.00)
DAT-7-292-10-RF	10,000	Vinyl	6	.80 (20.32)	1.437 (36.50)	.50 (12.70)	.90 (22.86)	1.50 (38.10)	6.30 (160.00)
DAT-52-642-1,-10	1,000/10,000	Polyvinylfluoride	6	.80 (20.32)	1.437 (36.50)	.50 (12.70)	.90 (22.86)	1.50 (38.10)	6.30 (160.00)
1.00" Label Width — 6 or 8 lines per inch									
DAT-185-292-1,-2.5	1,000/2,500	Vinyl	7	1.00 (25.40)	2.50 (63.50)	.75 (19.05)	1.10 (27.94)	3.00 (76.20)	8.60 (218.44)
DAT-187-292-1,-2.5	1,000/2,500	Vinyl	7	1.00 (25.40)	4.00 (101.60)	1.00 (25.40)	1.10 (27.94)	4.50 (114.30)	8.60 (218.44)
DAT-41-292*-1,-2.5	1,000/2,500	Vinyl	8	1.00 (25.40)	5.937 (150.80)	1.50 (38.10)	1.10 (27.94)	6.00 (152.40)	9.50 (241.30)
DAT-69-292-1,-2.5	1,000/2,500	Vinyl	7	1.00 (25.40)	5.937 (150.80)	1.50 (38.10)	1.10 (27.94)	6.00 (152.40)	8.40 (213.36)
DAT-69-292-OR**	2,500	Vinyl	7	1.00 (25.40)	5.937 (150.80)	1.50 (38.10)	1.10 (27.94)	6.00 (152.40)	8.40 (213.36)
DAT-69-292-GR**	2,500	Vinyl	7	1.00 (25.40)	5.937 (150.80)	1.50 (38.10)	1.10 (27.94)	6.00 (152.40)	8.40 (213.36)
DAT-69-292-PL**	2,500	Vinyl	7	1.00 (25.40)	5.937 (150.80)	1.50 (38.10)	1.10 (27.94)	6.00 (152.40)	8.40 (213.36)
DAT-69-292-BL**	2,500	Vinyl	7	1.00 (25.40)	5.937 (150.80)	1.50 (38.10)	1.10 (27.94)	6.00 (152.40)	8.40 (213.36)
DAT-69-292-BR**	2,500	Vinyl	7	1.00 (25.40)	5.937 (150.80)	1.50 (38.10)	1.10 (27.94)	6.00 (152.40)	8.40 (213.36)
DAT-69-292-YL**	2,500	Vinyl	7	1.00 (25.40)	5.937 (150.80)	1.50 (38.10)	1.10 (27.94)	6.00 (152.40)	8.40 (213.36)
DAT-69-292-RD**	2,500	Vinyl	7	1.00 (25.40)	5.937 (150.80)	1.50 (38.10)	1.10 (27.94)	6.00 (152.40)	8.40 (213.36)
DAT-69-292-GY**	2,500	Vinyl	7	1.00 (25.40)	5.937 (150.80)	1.50 (38.10)	1.10 (27.94)	6.00 (152.40)	8.40 (213.36)
DAT-42-292*-1,-2.5	1,000/2,500	Vinyl	8	1.00 (25.40)	7.437 (188.90)	1.50 (38.10)	1.10 (27.94)	7.50 (190.50)	9.50 (241.30)
DAT-70-292-1,-2.5	1,000/2,500	Vinyl	7	1.00 (25.40)	7.437 (188.90)	1.50 (38.10)	1.10 (27.94)	7.50 (190.50)	8.40 (213.36)
1.50" Label Width — 6 or 8 lines per inch									
DAT-186-292-1,-2.5	1,000/2,500	Vinyl	4	1.50 (38.10)	2.50 (63.50)	.75 (19.05)	1.60 (40.64)	3.00 (76.20)	7.30 (185.42)
DAT-188-292-1,-2.5	1,000/2,500	Vinyl	4	1.50 (38.10)	4.00 (101.60)	1.00 (25.40)	1.60 (40.64)	4.50 (114.30)	7.30 (185.42)
1.90" Label Width — 6 or 8 lines per inch									
DAT-8-292*-1,-2.5	1,000/2,500	Vinyl	4	1.90 (48.26)	3.187 (80.95)	.75 (19.05)	2.00 (50.80)	3.50 (88.90)	9.50 (241.30)
DAT-63-292-1,-2.5	1,000/2,500	Vinyl	3	1.90 (48.26)	3.187 (80.95)	.75 (19.05)	2.00 (50.80)	3.50 (88.90)	7.50 (190.50)

RF=These parts are supplied on a three inch core for those applications requiring a rollform feed mechanism into the printer. The parts are shipped with a 48 hour lead time.

*Size does not fit narrow carriage (80-column) printers. See p. 141 for identical narrow carriage labels.

**OR=orange, GR=green, GY=grey, PL=purple, BL=blue, BR=brown, YL=yellow, RD=red.
Standard product lead time of 10 working days.

Note: Labels in chart are sorted in order by width, height, 3 digit material number (within part number), then die number (within part number).

DOT MATRIX MARKERS INDEX BY SIZE

Self-Laminating Wire and Cable Markers by Size

CONTINUED

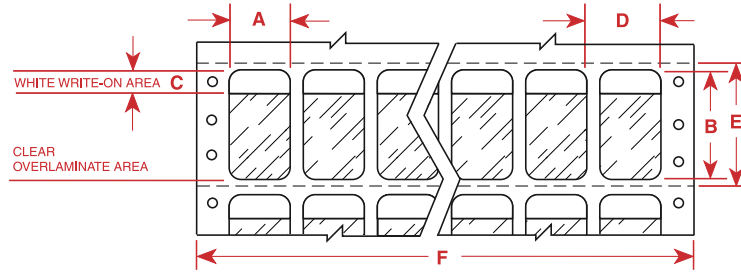

Part Number	Pieces Per Package	Material	Labels Per Row	Label Width In. (mm) A	Label Height In. (mm) B	Write-On Height In. (mm) C	Horizontal Repeat In. (mm) D	Vertical Repeat In. (mm) E	Web Width In. (mm) F
2.00" Label Width — 6 or 8 lines per inch									
DAT-9-292*-1,-2.5	1,000/2,500	Vinyl	6	2.00 (50.80)	5.937 (150.80)	1.50 (38.10)	2.10 (53.34)	6.00 (152.40)	13.50 (342.90)
DAT-75-292-1,-2.5	1,000/2,500	Vinyl	3	2.00 (50.80)	5.937 (150.80)	1.50 (38.10)	2.10 (53.34)	6.00 (152.40)	7.00 (177.80)
DAT-75-292-OR**	2,500	Vinyl	3	2.00 (50.80)	5.937 (150.80)	1.50 (38.10)	2.10 (53.34)	6.00 (152.40)	7.00 (177.80)
DAT-75-292-GR**	2,500	Vinyl	3	2.00 (50.80)	5.937 (150.80)	1.50 (38.10)	2.10 (53.34)	6.00 (152.40)	7.00 (177.80)
DAT-75-292-PL**	2,500	Vinyl	3	2.00 (50.80)	5.937 (150.80)	1.50 (38.10)	2.10 (53.34)	6.00 (152.40)	7.00 (177.80)
DAT-75-292-BL**	2,500	Vinyl	3	2.00 (50.80)	5.937 (150.80)	1.50 (38.10)	2.10 (53.34)	6.00 (152.40)	7.00 (177.80)
DAT-75-292-BR**	2,500	Vinyl	3	2.00 (50.80)	5.937 (150.80)	1.50 (38.10)	2.10 (53.34)	6.00 (152.40)	7.00 (177.80)
DAT-75-292-YL**	2,500	Vinyl	3	2.00 (50.80)	5.937 (150.80)	1.50 (38.10)	2.10 (53.34)	6.00 (152.40)	7.00 (177.80)
DAT-75-292-RD**	2,500	Vinyl	3	2.00 (50.80)	5.937 (150.80)	1.50 (38.10)	2.10 (53.34)	6.00 (152.40)	7.00 (177.80)
DAT-75-292-GY**	2,500	Vinyl	3	2.00 (50.80)	5.937 (150.80)	1.50 (38.10)	2.10 (53.34)	6.00 (152.40)	7.00 (177.80)
DAT-14-292*-1,-2.5	1,000/2,500	Vinyl	4	2.00 (50.80)	7.437 (188.90)	1.50 (38.10)	2.20 (55.88)	7.50 (190.50)	9.40 (238.76)
DAT-65-292-1,-2.5	1,000/2,500	Vinyl	3	2.00 (50.80)	7.437 (188.90)	1.50 (38.10)	2.10 (53.34)	7.50 (190.50)	7.20 (182.88)
DAT-159-292-1,-2.5	1,000/2,500	Vinyl	3	2.00 (50.80)	8.437 (214.30)	1.50 (38.10)	2.10 (53.34)	8.50 (215.90)	7.20 (182.88)
DAT-159-292-OR**	2,500	Vinyl	3	2.00 (50.80)	8.437 (214.30)	1.50 (38.10)	2.10 (53.34)	8.50 (215.90)	7.20 (182.88)
DAT-159-292-GR**	2,500	Vinyl	3	2.00 (50.80)	8.437 (214.30)	1.50 (38.10)	2.10 (53.34)	8.50 (215.90)	7.20 (182.88)
DAT-159-292-PL**	2,500	Vinyl	3	2.00 (50.80)	8.437 (214.30)	1.50 (38.10)	2.10 (53.34)	8.50 (215.90)	7.20 (182.88)
DAT-159-292-BL**	2,500	Vinyl	3	2.00 (50.80)	8.437 (214.30)	1.50 (38.10)	2.10 (53.34)	8.50 (215.90)	7.20 (182.88)
DAT-159-292-BR**	2,500	Vinyl	3	2.00 (50.80)	8.437 (214.30)	1.50 (38.10)	2.10 (53.34)	8.50 (215.90)	7.20 (182.88)
DAT-159-292-YL**	2,500	Vinyl	3	2.00 (50.80)	8.437 (214.30)	1.50 (38.10)	2.10 (53.34)	8.50 (215.90)	7.20 (182.88)
DAT-159-292-RD**	2,500	Vinyl	3	2.00 (50.80)	8.437 (214.30)	1.50 (38.10)	2.10 (53.34)	8.50 (215.90)	7.20 (182.88)
DAT-159-292-GY**	2,500	Vinyl	3	2.00 (50.80)	8.437 (214.30)	1.50 (38.10)	2.10 (53.34)	8.50 (215.90)	7.20 (182.88)

RF=These parts are supplied on a three inch core for those applications requiring a rollform feed mechanism into the printer. The parts are shipped with a 48 hour lead time.

*Wide Web. Will not fit narrow carriage (80-column printers). See p. 141 for identical narrow carriage labels.

**OR=orange, GR=green, GY=grey, PL=purple, BL=blue, BR=brown, YL=yellow, RD=red.
Standard product lead time of 10 working days.

Note: Labels in chart are sorted in order by width, height, 3 digit material number (within part number), then die number (within part number).

LASER, INK JET & DOT MATRIX LABELS

DOT MATRIX MARKERS INDEX BY SIZE

Self-Laminating Wire and Cable Markers by Size

CONTINUED

BUTT-CUT

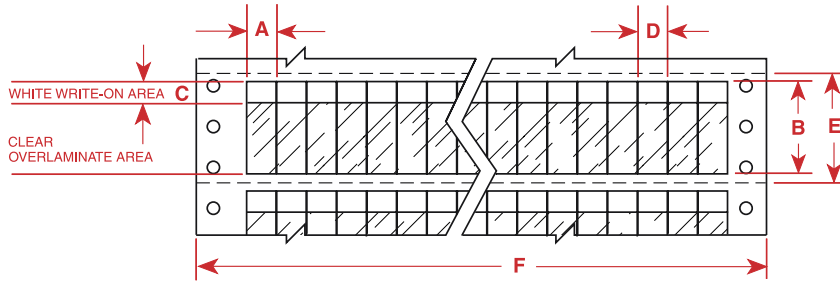

Part Number	Pieces Per Package	Material	Labels Per Row	Label Width In. (mm) A	Label Height In. (mm) B	Write-On Height In. (mm) C	Horizontal Repeat In. (mm) D	Vertical Repeat In. (mm) E	Web Width In. (mm) F
.30" Label Width — 6 or 8 lines per inch									
DAT-139-292-1,-10	1,000/10,000	Vinyl	16	.30 (762)	.75 (19.05)	.375 (9.53)	.30 (762)	1.00 (25.40)	5.80 (147.32)
DAT-142-292-1,-10	1,000/10,000	Vinyl	16	.30 (762)	.937 (23.80)	.375 (9.53)	.30 (762)	1.00 (25.40)	5.80 (147.32)
.50" Label Width — 6 or 8 lines per inch									
DAT-145-292-1,-10	1,000/10,000	Vinyl	16	.50 (12.70)	.937 (23.80)	.375 (9.53)	.50 (12.70)	1.00 (25.40)	9.00 (228.60)
DAT-33-292-1,-10	1,000/10,000	Vinyl	16	.50 (12.70)	1.437 (36.50)	.50 (12.70)	.50 (12.70)	1.50 (38.10)	9.00 (228.60)
DAT-33-292-10-RF	10,000	Vinyl	16	.50 (12.70)	1.437 (36.50)	.50 (12.70)	.50 (12.70)	1.50 (38.10)	9.00 (228.60)
DAT-53-642-1,-10	1,000/10,000	Polyvinylfluoride	16	.50 (12.70)	1.437 (36.50)	.50 (12.70)	.50 (12.70)	1.50 (38.10)	9.00 (228.60)
SLSH-0515	1,664	Vinyl	16	.50 (12.70)	1.437 (36.50)	.50 (12.70)	.50 (12.70)	1.50 (38.10)	9.00 (228.60)
.80" Label Width — 6 or 8 lines per inch									
DAT-148-292-1,-10	1,000/10,000	Vinyl	10	.80 (20.32)	.937 (23.80)	.375 (9.53)	.80 (20.32)	1.00 (25.40)	9.00 (228.60)
1.00" Label Width — 6 or 8 lines per inch									
DAT-85-292-1,-10	1,000/10,000	Vinyl	8	1.00 (25.40)	.75 (19.05)	.375 (9.53)	1.00 (25.40)	1.00 (25.40)	9.00 (228.60)
DAT-85-292-OR**	2,500	Vinyl	8	1.00 (25.40)	.75 (19.05)	.375 (9.53)	1.00 (25.40)	1.00 (25.40)	9.00 (228.60)
DAT-85-292-GR**	2,500	Vinyl	8	1.00 (25.40)	.75 (19.05)	.375 (9.53)	1.00 (25.40)	1.00 (25.40)	9.00 (228.60)
DAT-85-292-PL**	2,500	Vinyl	8	1.00 (25.40)	.75 (19.05)	.375 (9.53)	1.00 (25.40)	1.00 (25.40)	9.00 (228.60)
DAT-85-292-BL**	2,500	Vinyl	8	1.00 (25.40)	.75 (19.05)	.375 (9.53)	1.00 (25.40)	1.00 (25.40)	9.00 (228.60)
DAT-85-292-BR**	2,500	Vinyl	8	1.00 (25.40)	.75 (19.05)	.375 (9.53)	1.00 (25.40)	1.00 (25.40)	9.00 (228.60)
DAT-85-292-YL**	2,500	Vinyl	8	1.00 (25.40)	.75 (19.05)	.375 (9.53)	1.00 (25.40)	1.00 (25.40)	9.00 (228.60)
DAT-85-292-RD**	2,500	Vinyl	8	1.00 (25.40)	.75 (19.05)	.375 (9.53)	1.00 (25.40)	1.00 (25.40)	9.00 (228.60)
DAT-85-292-GY**	2,500	Vinyl	8	1.00 (25.40)	.75 (19.05)	.375 (9.53)	1.00 (25.40)	1.00 (25.40)	9.00 (228.60)
DAT-151-292-1,-10	1,000/10,000	Vinyl	8	1.00 (25.40)	.937 (23.80)	.375 (9.53)	1.00 (25.40)	1.00 (25.40)	9.00 (228.60)
DAT-34-292-1,-10	1,000/10,000	Vinyl	8	1.00 (25.40)	1.437 (36.50)	.50 (12.70)	1.00 (25.40)	1.50 (38.10)	9.00 (228.60)
DAT-34-292-10-RF	10,000	Vinyl	8	1.00 (25.40)	1.437 (36.50)	.50 (12.70)	1.00 (25.40)	1.50 (38.10)	9.00 (228.60)
DAT-34-292-OR**	2,500	Vinyl	8	1.00 (25.40)	1.437 (36.50)	.50 (12.70)	1.00 (25.40)	1.50 (38.10)	9.00 (228.60)
DAT-34-292-GR**	2,500	Vinyl	8	1.00 (25.40)	1.437 (36.50)	.50 (12.70)	1.00 (25.40)	1.50 (38.10)	9.00 (228.60)
DAT-34-292-PL**	2,500	Vinyl	8	1.00 (25.40)	1.437 (36.50)	.50 (12.70)	1.00 (25.40)	1.50 (38.10)	9.00 (228.60)
DAT-34-292-BL**	2,500	Vinyl	8	1.00 (25.40)	1.437 (36.50)	.50 (12.70)	1.00 (25.40)	1.50 (38.10)	9.00 (228.60)
DAT-34-292-BR**	2,500	Vinyl	8	1.00 (25.40)	1.437 (36.50)	.50 (12.70)	1.00 (25.40)	1.50 (38.10)	9.00 (228.60)
DAT-34-292-YL**	2,500	Vinyl	8	1.00 (25.40)	1.437 (36.50)	.50 (12.70)	1.00 (25.40)	1.50 (38.10)	9.00 (228.60)
DAT-34-292-RD**	2,500	Vinyl	8	1.00 (25.40)	1.437 (36.50)	.50 (12.70)	1.00 (25.40)	1.50 (38.10)	9.00 (228.60)
DAT-34-292-GY**	2,500	Vinyl	8	1.00 (25.40)	1.437 (36.50)	.50 (12.70)	1.00 (25.40)	1.50 (38.10)	9.00 (228.60)
DAT-54-642-1,-10	1,000/10,000	Polyvinylfluoride	8	1.00 (25.40)	1.437 (36.50)	.50 (12.70)	1.00 (25.40)	1.50 (38.10)	9.00 (228.60)
SLSH-1015	832	Vinyl	8	1.00 (25.40)	1.437 (36.50)	.50 (12.70)	1.00 (25.40)	1.50 (38.10)	9.00 (228.60)
DAT-37-292-1,-10	1,000/10,000	Vinyl	8	1.00 (25.40)	2.25 (57.15)	.75 (19.05)	1.00 (25.40)	2.50 (63.50)	9.00 (228.60)
DAT-37-292-10-RF	10,000	Vinyl	8	1.00 (25.40)	2.25 (57.15)	.75 (19.05)	1.00 (25.40)	2.50 (63.50)	9.00 (228.60)
DAT-37-292-OR**	2,500	Vinyl	8	1.00 (25.40)	2.25 (57.15)	.75 (19.05)	1.00 (25.40)	2.50 (63.50)	9.00 (228.60)
DAT-37-292-GR**	2,500	Vinyl	8	1.00 (25.40)	2.25 (57.15)	.75 (19.05)	1.00 (25.40)	2.50 (63.50)	9.00 (228.60)
DAT-37-292-PL**	2,500	Vinyl	8	1.00 (25.40)	2.25 (57.15)	.75 (19.05)	1.00 (25.40)	2.50 (63.50)	9.00 (228.60)
DAT-37-292-BL**	2,500	Vinyl	8	1.00 (25.40)	2.25 (57.15)	.75 (19.05)	1.00 (25.40)	2.50 (63.50)	9.00 (228.60)
DAT-37-292-BR**	2,500	Vinyl	8	1.00 (25.40)	2.25 (57.15)	.75 (19.05)	1.00 (25.40)	2.50 (63.50)	9.00 (228.60)
DAT-37-292-YL**	2,500	Vinyl	8	1.00 (25.40)	2.25 (57.15)	.75 (19.05)	1.00 (25.40)	2.50 (63.50)	9.00 (228.60)
DAT-37-292-RD**	2,500	Vinyl	8	1.00 (25.40)	2.25 (57.15)	.75 (19.05)	1.00 (25.40)	2.50 (63.50)	9.00 (228.60)
DAT-37-292-GY**	2,500	Vinyl	8	1.00 (25.40)	2.25 (57.15)	.75 (19.05)	1.00 (25.40)	2.50 (63.50)	9.00 (228.60)
SLSH-10225	608	Vinyl	8	1.00 (25.40)	2.25 (57.15)	.75 (19.05)	1.00 (25.40)	2.50 (63.50)	9.00 (228.60)

RF=These parts are supplied on a three inch core for those applications requiring a rollform feed mechanism into the printer. The parts are shipped with a 48 hour lead time.

**OR=orange, GR=green, GY=grey, PL=purple, BL=blue, BR=brown, YL=yellow, RD=red. Standard product lead time of 10 working days.

Note: Labels in chart are sorted in order by width, height, 3 digit material number (within part number), then die number (within part number).

Self-Laminating Wire and Cable Markers by Size

CONTINUED

▶ BUTT-CUT CONTINUED

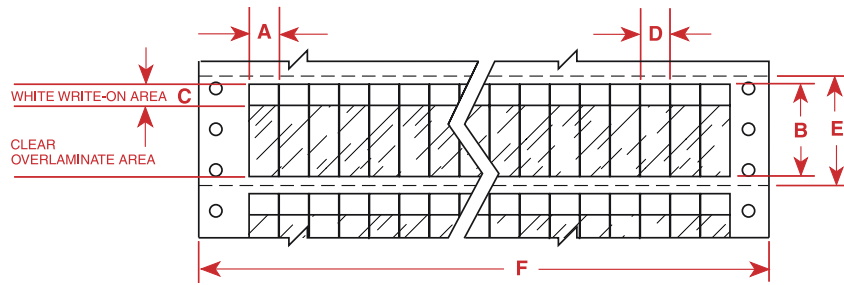

Part Number	Pieces Per Package	Material	Labels Per Row	Label Width In. (mm) A	Label Height In. (mm) B	Write-On Height In. (mm) C	Horizontal Repeat In. (mm) D	Vertical Repeat In. (mm) E	Web Width In. (mm) F
1.00" Label Width — 6 or 8 lines per inch (Cont.)									
DAT-39-292-1-2.5	1,000/2,500	Vinyl	8	1.00 (25.40)	3.75 (95.25)	1.00 (25.40)	1.00 (25.40)	4.00 (101.60)	9.00 (228.60)
DAT-39-292-RF	2,500	Vinyl	8	1.00 (25.40)	3.75 (95.25)	1.00 (25.40)	1.00 (25.40)	4.00 (101.60)	9.00 (228.60)
DAT-39-292-OR**	2,500	Vinyl	8	1.00 (25.40)	3.75 (95.25)	1.00 (25.40)	1.00 (25.40)	4.00 (101.60)	9.00 (228.60)
DAT-39-292-GR**	2,500	Vinyl	8	1.00 (25.40)	3.75 (95.25)	1.00 (25.40)	1.00 (25.40)	4.00 (101.60)	9.00 (228.60)
DAT-39-292-PL**	2,500	Vinyl	8	1.00 (25.40)	3.75 (95.25)	1.00 (25.40)	1.00 (25.40)	4.00 (101.60)	9.00 (228.60)
DAT-39-292-BL**	2,500	Vinyl	8	1.00 (25.40)	3.75 (95.25)	1.00 (25.40)	1.00 (25.40)	4.00 (101.60)	9.00 (228.60)
DAT-39-292-BR**	2,500	Vinyl	8	1.00 (25.40)	3.75 (95.25)	1.00 (25.40)	1.00 (25.40)	4.00 (101.60)	9.00 (228.60)
DAT-39-292-YL**	2,500	Vinyl	8	1.00 (25.40)	3.75 (95.25)	1.00 (25.40)	1.00 (25.40)	4.00 (101.60)	9.00 (228.60)
DAT-39-292-RD**	2,500	Vinyl	8	1.00 (25.40)	3.75 (95.25)	1.00 (25.40)	1.00 (25.40)	4.00 (101.60)	9.00 (228.60)
DAT-39-292-GY**	2,500	Vinyl	8	1.00 (25.40)	3.75 (95.25)	1.00 (25.40)	1.00 (25.40)	4.00 (101.60)	9.00 (228.60)
SLSH-10375	408	Vinyl	8	1.00 (25.40)	3.75 (95.25)	1.00 (25.40)	1.00 (25.40)	4.00 (101.60)	9.00 (228.60)
2.00" Label Width — 6 or 8 lines per inch									
DAT-35-292-1-10	1,000/10,000	Vinyl	4	2.00 (50.80)	1.437 (36.50)	.50 (12.70)	2.00 (50.80)	1.50 (38.10)	9.00 (228.60)
SLSH-2015	416	Vinyl	4	2.00 (50.80)	1.437 (36.50)	.50 (12.70)	2.00 (50.80)	1.50 (38.10)	9.00 (228.60)
DAT-38-292-1-2.5	1,000/2,500	Vinyl	4	2.00 (50.80)	2.25 (57.15)	.75 (19.05)	2.00 (50.80)	2.50 (63.50)	9.00 (228.60)
DAT-38-292-OR**	2,500	Vinyl	4	2.00 (50.80)	2.25 (57.15)	.75 (19.05)	2.00 (50.80)	2.50 (63.50)	9.00 (228.60)
DAT-38-292-BR**	2,500	Vinyl	4	2.00 (50.80)	2.25 (57.15)	.75 (19.05)	2.00 (50.80)	2.50 (63.50)	9.00 (228.60)
DAT-38-292-GR**	2,500	Vinyl	4	2.00 (50.80)	2.25 (57.15)	.75 (19.05)	2.00 (50.80)	2.50 (63.50)	9.00 (228.60)
DAT-38-292-PL**	2,500	Vinyl	4	2.00 (50.80)	2.25 (57.15)	.75 (19.05)	2.00 (50.80)	2.50 (63.50)	9.00 (228.60)
DAT-38-292-BL**	2,500	Vinyl	4	2.00 (50.80)	2.25 (57.15)	.75 (19.05)	2.00 (50.80)	2.50 (63.50)	9.00 (228.60)
DAT-38-292-YL**	2,500	Vinyl	4	2.00 (50.80)	2.25 (57.15)	.75 (19.05)	2.00 (50.80)	2.50 (63.50)	9.00 (228.60)
DAT-38-292-RD**	2,500	Vinyl	4	2.00 (50.80)	2.25 (57.15)	.75 (19.05)	2.00 (50.80)	2.50 (63.50)	9.00 (228.60)
DAT-38-292-GY**	2,500	Vinyl	4	2.00 (50.80)	2.25 (57.15)	.75 (19.05)	2.00 (50.80)	2.50 (63.50)	9.00 (228.60)
SLSH-20225	304	Vinyl	4	2.00 (50.80)	2.25 (57.15)	.75 (19.05)	2.00 (50.80)	2.50 (63.50)	9.00 (228.60)
DAT-40-292-1-2.5	1,000/2,500	Vinyl	4	2.00 (50.80)	3.75 (95.25)	1.00 (25.40)	2.00 (50.80)	4.00 (101.60)	9.00 (228.60)
DAT-40-292-OR**	2,500	Vinyl	4	2.00 (50.80)	3.75 (95.25)	1.00 (25.40)	2.00 (50.80)	4.00 (101.60)	9.00 (228.60)
DAT-40-292-GR**	2,500	Vinyl	4	2.00 (50.80)	3.75 (95.25)	1.00 (25.40)	2.00 (50.80)	4.00 (101.60)	9.00 (228.60)
DAT-40-292-PL**	2,500	Vinyl	4	2.00 (50.80)	3.75 (95.25)	1.00 (25.40)	2.00 (50.80)	4.00 (101.60)	9.00 (228.60)
DAT-40-292-BL**	2,500	Vinyl	4	2.00 (50.80)	3.75 (95.25)	1.00 (25.40)	2.00 (50.80)	4.00 (101.60)	9.00 (228.60)
DAT-40-292-BR**	2,500	Vinyl	4	2.00 (50.80)	3.75 (95.25)	1.00 (25.40)	2.00 (50.80)	4.00 (101.60)	9.00 (228.60)
DAT-40-292-YL**	2,500	Vinyl	4	2.00 (50.80)	3.75 (95.25)	1.00 (25.40)	2.00 (50.80)	4.00 (101.60)	9.00 (228.60)
DAT-40-292-RD**	2,500	Vinyl	4	2.00 (50.80)	3.75 (95.25)	1.00 (25.40)	2.00 (50.80)	4.00 (101.60)	9.00 (228.60)
DAT-40-292-GY**	2,500	Vinyl	4	2.00 (50.80)	3.75 (95.25)	1.00 (25.40)	2.00 (50.80)	4.00 (101.60)	9.00 (228.60)
SLSH-20375	204	Vinyl	4	2.00 (50.80)	3.75 (95.25)	1.00 (25.40)	2.00 (50.80)	4.00 (101.60)	9.00 (228.60)

RF=These parts are supplied on a three inch core for those applications requiring a rollform feed mechanism into the printer. The parts are shipped with a 48 hour lead time.

**OR=orange, GR=green, GY=grey, PL=purple, BL=blue, BR=brown, YL=yellow, RD=red.
Standard product lead time of 10 working days.

Note: Labels in chart are sorted in order by width, height, 3 digit material number (within part number), then die number (within part number).

LASER, INK JET & DOT MATRIX LABELS

DOT MATRIX MARKERS INDEX BY SIZE

Self-Laminating Wire and Cable Markers by Size

CONTINUED

LASER, INK JET & DOT MATRIX LABELS

CABLE MARKERS

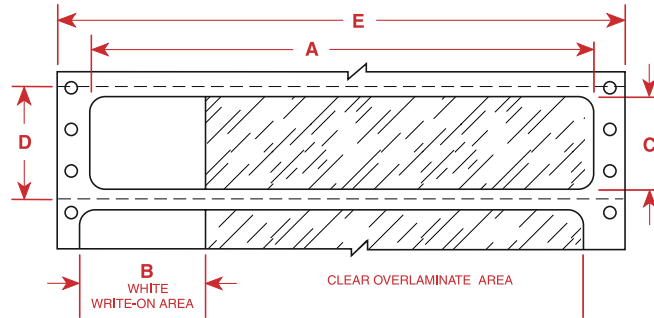

Part Number	Pieces Per Package	Material	Labels Per Row	Label Height In. (mm) A	Write-On Height In. (mm) B	Label Width In. (mm) C	Vertical Repeat In. (mm) D	Web Width In. (mm) E
8.50" Label Width — 6 or 8 lines per inch								
DAT-162-292-1,-2,5	1,000/2,500	Vinyl	1	8.50 (215.90)	1.50 (38.10)	2.00 (50.80)	2.50 (63.50)	9.50 (241.30)

Note: Labels in chart are sorted in order by width, height, 3 digit material number (within part number), then die number (within part number).

Cable Markers by Size

BRADYWRAP™

Continuous strip/cut-to-length

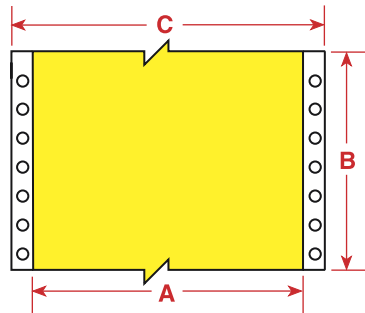

Part Number	Roll Length Ft. (m)	Material	Color	Label Width In. (mm) A	Label Height In. (mm) B	Web Width In. (mm) C	Maximum Characters Across		
							5 CPI	10 CPI	17 CPI
1.00" Label Width — 6 or 8 lines per inch									
RCM-637-1.0-WT	100 (30)	Tedlar®	White	1.00 (25.40)	Continuous	3.60 (91.44)	4	9	15
RCM-637-1.0-YL	100 (30)	Tedlar	Yellow	1.00 (25.40)	Continuous	3.60 (91.44)	4	9	15
1.50" Label Width — 6 or 8 lines per inch									
RCM-637-1.5-WT	100 (30)	Tedlar	White	1.50 (38.10)	Continuous	3.60 (91.44)	7	14	23
RCM-637-1.5-YL	100 (30)	Tedlar	Yellow	1.50 (38.10)	Continuous	3.60 (91.44)	7	14	23
2.00" Label Width — 6 or 8 lines per inch									
RCM-330-2.0-WT	100 (30)	Polyolefin	White	2.00 (50.80)	Continuous	3.60 (91.44)	9	19	32
RCM-330-2.0-YL	100 (30)	Polyolefin	Yellow	2.00 (50.80)	Continuous	3.60 (91.44)	9	19	32
RCM-637-2.0-WT	100 (30)	Tedlar	White	2.00 (50.80)	Continuous	3.60 (91.44)	9	19	32
RCM-637-2.0-YL	100 (30)	Tedlar	Yellow	2.00 (50.80)	Continuous	3.60 (91.44)	9	19	32

Tedlar® is a registered trademark of DuPont.

Note: Labels in chart are sorted in order by width, height, 3 digit material number (within part number), then die number (within part number).

DOT MATRIX MARKERS INDEX BY SIZE

Cable Markers by Size

CONTINUED

LASER, INK JET & DOT MATRIX LABELS

CONNECTOR PULL-TABS

Flat cable markers

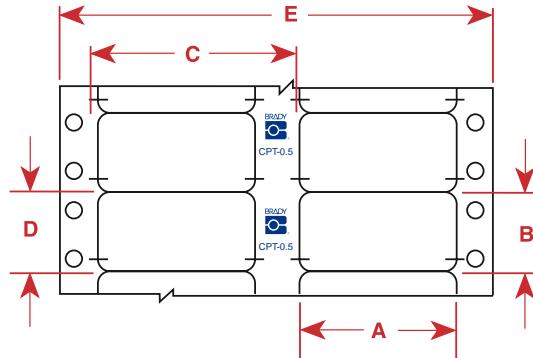

Part Number	Labels Per Roll	Material	Color	Labels Per Row	Label Width In. (mm) A	Label Height In. (mm) B	Horizontal Repeat In. (mm) C	Vertical Repeat In. (mm) D	Web Width In. (mm) E
3.00" Label Width — 6 or 8 lines per inch									
CPT-0.5	500	B-505 Flame-Resistant Polyester	White	2	3.00 (76.20)	.50 (12.70)	3.50 (88.90)	.50 (12.70)	7.50 (190.50)
CPT-1.0	500	B-505 Flame-Resistant Polyester	White	2	3.00 (76.20)	1.00 (25.40)	3.50 (88.90)	1.00 (25.40)	7.50 (190.50)
CPT-1.5	500	B-505 Flame-Resistant Polyester	White	2	3.00 (76.20)	1.50 (38.10)	3.50 (88.90)	1.50 (38.10)	7.50 (190.50)
CPT-2.0	500	B-505 Flame-Resistant Polyester	White	2	3.00 (76.20)	2.00 (50.80)	3.50 (88.90)	2.00 (50.80)	7.50 (190.50)
CPT-2.5	500	B-505 Flame-Resistant Polyester	White	2	3.00 (76.20)	2.50 (63.50)	3.50 (88.90)	2.50 (63.50)	7.50 (190.50)
CPT-3.25	500	B-505 Flame-Resistant Polyester	White	2	3.00 (76.20)	3.25 (82.55)	3.50 (88.90)	3.25 (82.55)	7.50 (190.50)

Note: Labels in chart are sorted in order by width, height, 3 digit material number (within part number), then die number (within part number).

CLOTH TAGS

Cable and wire harness markers

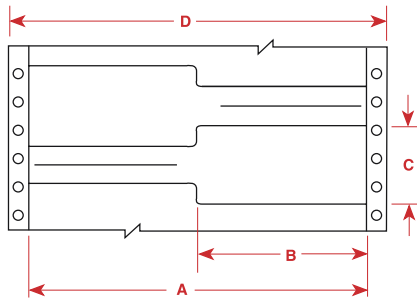

Part Number	Pieces Per Package	Material	Color	Labels Per Row	Label Width In. (mm) A	Width of Write-On Area In. (mm) B	Label Height In. (mm) C	Web Width In. (mm) D
4.50" Label Width (2.25" tab area) — 6 or 8 lines per inch								
CT-1	1,800	B-503 Self-Extinguishing Cloth	White	2	4.50 (114.30)	2.25 (57.15)	1.00 (25.40)	5.50 (139.70)

Note: Labels in chart are sorted in order by width, height, 3 digit material number (within part number), then die number (within part number).

DOT MATRIX MARKERS INDEX BY SIZE

Bradytag™ Labels by Size

LASER, INK JET & DOT MATRIX LABELS

COMPUTER-PRINTABLE TAGS

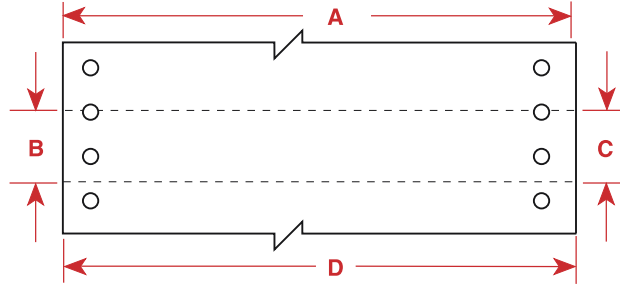

Part Number	Pieces Per Package	Material	Color	Labels Per Row	Label Width In. (mm) A	Label Height In. (mm) B	Vertical Repeat In. (mm) C	Web Width In. (mm) D
3.00" Label Width — 6 or 8 lines per inch								
BT-0530	500	B-620 Matte Polyester	White	1	3.00 (76.20)	.50 (12.70)	.50 (12.70)	3.00 (76.20)
BT-1030	500	B-620 Matte Polyester	White	1	3.00 (76.20)	1.00 (25.40)	1.00 (25.40)	3.00 (76.20)
BT-109W-3060-1	100	B-109 Polyethylene	White	1	3.00 (76.20)	6.00 (152.40)	6.00 (152.40)	4.00 (101.60)
BT-109W-3060-2	100	B-109 Polyethylene	White	2	3.00 (76.20)	6.00 (152.40)	6.00 (152.40)	4.00 (101.60)
BT-1530	500	B-620 Matte Polyester	White	1	3.00 (76.20)	1.50 (38.10)	1.50 (38.10)	3.00 (76.20)
BT-2030	500	B-620 Matte Polyester	White	1	3.00 (76.20)	2.00 (50.80)	2.00 (50.80)	3.00 (76.20)
3.50" Label Width — 6 or 8 lines per inch								
BT-2535	500	B-620 Matte Polyester	White	1	3.50 (88.90)	2.50 (63.50)	2.50 (63.50)	3.50 (88.90)
3.75" Label Width — 6 or 8 lines per inch								
BT-109W-2037	100	B-109 Polyethylene	White	1	3.75 (95.25)	2.00 (50.80)	2.00 (50.80)	4.75 (120.65)
4.75" Label Width — 6 or 8 lines per inch								
BT-109W-2547	100	B-109 Polyethylene	White	1	4.75 (120.65)	2.50 (63.50)	2.50 (63.50)	5.75 (146.05)

Note: Labels in chart are sorted in order by width, height, 3 digit material number (within part number), then die number (within part number).

NOMEX® CABLE AND HARNESS MARKING

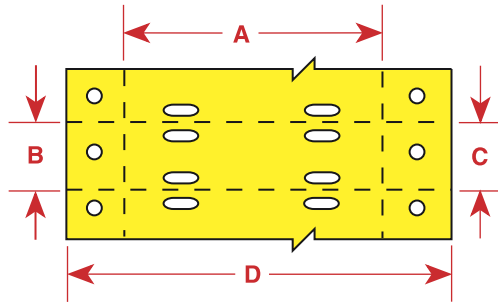

Part Number	Pieces Per Package	Material	Color	Labels Per Row	Holes Per Tag	Label Width In. (mm) A	Label Height In. (mm) B	Vertical Repeat In. (mm) C	Web Width In. (mm) D
2.00" Label Width — 6 or 8 lines per inch									
BT-508W-2050	2,500	B-508 Nomex	White	1	4	2.00 (50.80)	.50 (12.70)	.50 (12.70)	3.00 (76.2)
BT-508Y-2050	2,500	B-508 Nomex	Yellow	1	4	2.00 (50.80)	.50 (12.70)	.50 (12.70)	3.00 (76.2)
BT-508W-2075	2,500	B-508 Nomex	White	1	6	2.00 (50.80)	.75 (19.05)	.75 (19.05)	3.00 (76.2)
BT-508Y-2075	2,500	B-508 Nomex	Yellow	1	6	2.00 (50.80)	.75 (19.05)	.75 (19.05)	3.00 (76.2)

Nomex® is a registered trademark of DuPont.

Note: Labels in chart are sorted in order by width, height, 3 digit material number (within part number), then die number (within part number).

DOT MATRIX LABELS INDEX BY SIZE